

Mobile Elevating Work Platforms

Scissors, Verticals, Stock Pickers & Low Level Access

REV 08.22.2024

R SERIES

R1932/R2632/R2646/R3246 Scissor Lifts

	R1932	R2632	R2646	R3246
Platform Height (Indoor)	19-ft / 5.8-m	25-ft 5-in / 7.8-m	26-ft / 7.92-m	32-ft / 9.8-m
Platform Height (Outdoor)	19-ft / 5.8-m	21-ft / 6.4-m	26-ft / 7.92-m	32-ft / 9.75-m
Platform Height - Lowered	38.6-in / .981-m	43.6-in / 1.11-m	45-in / 1.14-m	50.9-in / 1.29-m
No. Occupants (Indoor)	2	2	2	2
No. Occupants (Outdoor)	1	1	1	1
Platform Railing Height	43.3-in / 1.10-m	44.6-in / 1.13-m	44.6-in / 1.13-m	44.6-in / 1.13-m
Overall Height	82.8-in / 2.10-m	88.2-in / 2.24-m	89.6-in / 2.28-m	96.3-in / 2.45-m
— With Rails Folded	64.3-in / 1.63-m	70.3-in / 1.79-m	71.7-in / 1.82-m	77.6-in / 1.97-m
Platform Dimensions ¹	65.5 x 30.3-in / 1.66 x .77-m	87.6 x 27.7-in / 2.22 x .70-m	87.6 x 41.5-in / 2.22 x 1.05-m	87.6 x 41.5-in / 2.22 x 1.05-m
— Platform Extension	36-in / 91-cm	34-in / 86.5-cm	36-in / 91-cm	36-in / 91-cm
Overall Machine Length	68.7-in / 1.74-m	94.3-in / 2.40-m	94.3-in / 2.4-m	94.3-in / 2.40-m
Overall Machine Width	32-in / 81-cm	32-in / 81-cm	46-in / 117-cm	46-in / 117-cm
Wheelbase	53-in / 1.34-m	74-in / 1.88-m	74-in / 1.88-m	74-in / 1.88-m
Ground Clearance	2.8-in / 7-cm	3.9-in / 9.8-cm	3.9-in / 9.8-cm	3.9-in / 9.8-cm
Platform Capacity (Indoor)	507-lb / 230-kg	507-lb / 230-kg	1,200-lb / 545-kg	705-lb / 320-kg
Platform Capacity (Outdoor)	507-lb / 230-kg	275-lb / 125-kg	1,200-lb / 545-kg	507-lb / 230-kg
— Capacity on Deck Extension	265-lb / 120-kg	265-lb / 120-kg	265-lb / 120-kg	265-lb / 120-kg
Lift/Lower Time (No Load)	20/27 seconds	33/36 seconds	47/44 seconds	42/44 seconds
Lift/Lower Time (Rated Load)	25/26 seconds	39/29 seconds	54/37 seconds	50/37 seconds
Maximum Drive Height (Indoor)	Full Height	Full Height	Full Height	Full Height
Maximum Drive Height (Outdoor)	Full Height	21-ft / 6.4-m	Full Height	Full Height
Weight*	3,450-lb / 1,564-kg	4,280-lb / 1,941-kg	5,267-lb / 2,389-kg	5,410-lb / 2,454-kg
Ground Bearing Pressure	114 psi / 8.0-kg/cm ²	92 psi / 6.5-kg/cm ²	122 psi / 8.6-kg/cm ²	131 psi / 9.21-kg/cm ²
Drive Speed—Lowered	2.1 mph / 3.4 km/h	2.2 mph / 3.5 km/h	3 mph / 4.8 km/h	2.2 mph / 3.5 km/h
Drive Speed—Elevated	0.5 mph / 0.8 km/h	0.5 mph / 0.8 km/h	0.5 mph / 0.8 km/h	0.5 mph / 0.8 km/h
Max Tilt Rating				
— Indoor (Side to Side)	1.75 Degrees	1.50 Degrees	2.50 Degrees	2.50 Degrees
— Outdoor (Side to Side)	1.50 Degrees	1.50 Degrees	1.50 Degrees	1.50 Degrees
Fore and Aft	3.75 Degrees	3.50 Degrees	3.50 Degrees	3.50 Degrees
Gradeability	25%	25%	25%	25%
Turning Radius (Inside)	Zero	Zero	Zero	Zero
Turning Radius (Outside)	66-in / 1.68-m	88.2-in / 2.24-m	88-in / 2.24-m	88-in / 2.24-m
Max Wind Speed Rating	28 mph / 12.5 m/s	28 mph / 12.5 m/s	28 mph / 12.5 m/s	28 mph / 12.5 m/s
Tire Size - Non-Marking Solid	12.7 x 4-in / 323 x 100-mm	16 x 5-in / 406 x 127-mm	16 x 5-in / 406 x 125 mm	16 x 5-in / 406 x 127-mm
Batteries	4 x 6V 220 amp-hr	4 x 6V 220 amp-hr	4 x 6V 220 amp-hr	4 x 6V 220 amp-hr
Charger	27 amp	27 amp	27 amp	27 amp
Pump	Fixed Displacement Gear	Fixed Displacement Gear	Fixed Displacement Gear	Fixed Displacement Gear
Hydraulic Reservoir	4 gal / 15 L	4.8 gal / 18 L	4 gal / 15 L	4 gal / 15 L
Brakes (On Drive Wheels)	Multi-Disc Friction	Multi-Disc Friction	Multi-Disc Friction	Multi-Disc Friction
Rail Type	Fold-Down	Fold-Down	Fold-Down	Fold-Down
Drive	Hydraulic Front Wheel	Hydraulic Front Wheel	Hydraulic Front Wheel	Hydraulic Front Wheel

*Certain weights and dimensions may vary due to options and to compliance with country standards. Specifications may change to meet country standards or with addition of optional equipment.

R1932i Indoor-only model available, consult factory

1. Dimensions reflect outside measurements.

LIGHTWEIGHT ES SERIES

ES1330L / ES1530L Scissor Lifts

	ES1330L	ES1530L
Platform Height—Elevated (Indoor)	13-ft / 3.8-m	15-ft / 4.5-m
Platform Height - Elevated (Outdoor)	13-ft / 3.8-m	10-ft / 3-m
Platform Height—Lowered	28.0-in / 70-cm	31.1-in / 80-cm
Platform Capacity	500-lb / 227-kg	500-lb / 227-kg
—Capacity on Deck Extension	250-lb / 115-kg	250-lb / 115-kg
No. Occupants (Indoor)	2	1
No. Occupants (Outdoor)	1	1
Platform Railing Height	43.3-in / 1.1-m	43.3-in / 1.1-m
Overall Height	71.7-in / 1.8-m	74.8-in / 1.9-m
Platform Dimensions ¹	52.8 x 27.6-in / 1.34 x .70-m	52.8 x 27.6-in / 1.34 x .70-m
—Platform Extension	21.6-in / 55-cm	21.6-in / 55-cm
Overall Machine Length	56.2-in / 1.4-m	56.2-in / 1.4-m
Overall Machine Width	30-in / 76-cm	30-in / 76-cm
Wheelbase	42.3-in / 1.1-m	42.3-in / 1.1-m
Ground Clearance	2.4-in / 6-cm	2.4-in / 6-cm
Lift/Lower Time (No Load)	17/17 seconds	19/19 seconds
Lift/Lower Time (Rated Load)	20/16 seconds	22/17 seconds
Maximum Drive Height (Indoor)	13-ft / 3.8-m	15-ft / 4.5-m
Maximum Drive Height (Outdoor)	13-ft / 3.8-m	10-ft / 4.5-m
Weight*	1,984-lb / 900-kg	1,940-lb / 880-kg
Ground Bearing Pressure	119 psi / 8.3-kg/cm ²	126 psi / 8.82-kg/cm ²
Drive Speed—Lowered	2.4 mph / 3.8 km/h	2.4 mph / 3.8 km/h
Drive Speed—Elevated	0.5 mph / .8 km/h	0.5 mph / .8 km/h
Max Tilt Rating		
— Indoor (side to side)	1.75 Degrees	2.5 Degrees
— Outdoor (side to side)	1.50 Degrees	1.50 Degrees
Fore and Aft	3 Degrees	3 Degrees
Gradeability	25%	25%
Turning Radius (Inside)	Zero	Zero
Turning Radius (Outside)	55-in / 1.4-m	55-in / 1.4-m
Max Wind Speed Rating	28 mph / 12.5 m/s	28 mph / 12.5 m/s
Tire Size (Non-Marking Solid)	10 x 3-in / 255 x 75-mm	10 x 3-in / 255 x 75-mm
Batteries	2 x 12V 105 amp-hr	2 x 12V 105 amp-hr
Charger	27 Amp	27 Amp
Pump	Fixed Displacement Gear	Fixed Displacement Gear
Hydraulic Reservoir	1.3 gal / 5 L	1.3 gal / 5 L
Brakes (On Drive Wheels)	Electric, Friction	Electric, Friction
Rail Type	Fixed	Fixed
Drive	24V DC	24V DC

*Certain weights and dimensions may vary due to options and to compliance with country standards. Specifications may change to meet country standards or with addition of optional equipment.

1. Dimensions reflect outside measurements.

ES SERIES

ES1932/ES2632/ES2646/ES3246/ES4046 Scissor Lifts

	ES1932	ES2632	ES2646	ES3246	ES4046
Platform Height—Elevated (Indoor)	19-ft / 5.8-m	25-ft 5-in / 7.8-m	26-ft / 7.92-m	32-ft / 9.8-m	39.1-ft / 11.9-m
Platform Height—Elevated (Outdoor)	19-ft / 5.8-m	21-ft / 6.4-m	26-ft / 7.92-m	32-ft / 9.8-m	28-ft 8.5-in / 8.75-m
Platform Height—Lowered	38.6-in / 981-m	43.6-in / 1.11-m	45.0-in / 1.14-m	50.9-in / 1.29-m	54.8-in / 1.4-m
Platform Capacity (Indoor)	507-lb / 230-kg	507-lb / 230-kg	1,200-lb / 545-kg	705-lb / 320-kg	770-lb / 349.3-kg
Platform Capacity (Outdoor)	507-lb / 230-kg	275-lb / 125-kg	1,200-lb / 545-kg	507-lb / 230-kg	550-lb / 249.5-kg
—Capacity on Deck Extension	265-lb / 120-kg	265-lb / 120-kg	265-lb / 120-kg	265-lb / 120-kg	250-lb / 113.4-kg
No. Occupants (Indoor)	2	2	2	2	3
No. Occupants (Outdoor)	1	1	1	1	1
Platform Railing Height	44.6-in / 1.13-m	44.6-in / 1.13-m	44.6-in / 1.13-m	44.6-in / 1.13-m	44.6-in / 1.13-m
Overall Height	82.8-in / 2.10-m	88.2-in / 2.24-m	89.6-in / 2.28-m	96.3-in / 2.45-m	99.5-in / 2.53-m
—With Rails Folded	78.2-in / 1.99-m	70.3-in / 1.8-m	71.7-in / 1.82-m	77.6-in / 1.97-m	78.5-in / 1.99-m
Platform Dimensions ¹	62.7 x 25.4-in / 1.59 x .64-m	87.6 x 27.7-in / 2.22 x .70-m	87.6 x 41.5-in / 2.22 x 1.05-m	87.6 x 41.5-in / 2.22 x 1.05-m	97.1 x 37.4-in / 2.47 x 0.95-m
—Platform Extension	36-in / 91-cm	34-in / 86.5-cm	36-in / 91-cm	36-in / 91-cm	36-in / 91.4-cm
Overall-machine Length	68.7-in / 1.74-m	94.3-in / 2.4-m	94.3-in / 2.4-m	94.3-in / 2.4-m	106.6-in / 2.7-m
Overall-machine Width	32-in / 81-cm	32-in / 81-cm	46-in / 117-cm	46-in / 117-cm	46-in / 117-cm
Wheelbase	53-in / 1.34-m	74-in / 1.88-m	74-in / 1.88-m	74-in / 1.88-m	80.4-in / 2.04-m
Ground Clearance	2.8-in / 7-cm	3.9-in / 9.8-cm	3.9-in / 9.8-cm	3.9-in / 9.8-cm	4.8-in / 12.19-cm
Lift/Lower Time (No Load)	22/29 seconds	38/40 seconds	49/44 seconds	51/48 seconds	66/52 Seconds
Lift/Lower Time (Rated Load)	27/28 seconds	46/34 seconds	62/37 seconds	54/41 seconds	76/42 seconds
Maximum Drive Height (Indoor)	19-ft / 5.79-m	Full Height	Full Height	Full Height	38.1-ft / 11.6-m
Maximum Drive Height (Outdoor)	19-ft / 5.79-m	21-ft / 9.8-m	Full Height	Full Height	28-ft / 8.75-m
Weight*	3,450-lb / 1,565-kg	4,400-lb / 1,996-kg	5,295-lb / 2,401-kg	5,620-lb / 2,549.19-kg	6,230-lb / 2826-kg
Ground Bearing Pressure	114 psi / 8.0 kg/cm ²	107 psi / 7.5 kg/cm ²	137 psi / 9.6 kg/cm ²	140 psi / 9.8 kg/cm ²	152psi / 10.7 kg/cm ²
Drive Speed—Lowered	3 mph / 4.8 km/h	2.75 mph / 4.4 km/h	3 mph / 4.8 km/h	3 mph / 4.8 km/h	3 mph / 4.8 kmh
Drive Speed—Elevated	0.5 mph / 0.8 km/h	0.5 mph / 0.8 km/h	0.5 mph / 0.8 km/h	0.5 mph / 0.8 km/h	0.5 mph / 0.8 km/h
Max Tilt Rating					
— Indoor	1.75 Degrees	1.50 Degrees	2.50 Degrees	2.50 Degrees	2.50 Degrees
— Outdoor	1.50 Degrees	1.50 Degrees	1.50 Degrees	1.50 Degrees	1.50 Degrees
— Fore and Aft	3.75 Degrees	3.50 Degrees	3.50 Degrees	3.50 Degrees	3.50 Degrees
Gradeability	25%	25%	25%	25%	25%
Turning Radius (Inside)	Zero	Zero	Zero	Zero	Zero
Turning Radius (Outside)	66-in / 1.68-m	88.2-in / 2.24-m	88-in / 2.24-m	88-in / 2.24-m	94.4-in / 2.39-m
Max Wind Speed Rating	28 mph / 12.5 m/s	28 mph / 12.5 m/s	28 mph / 12.5 m/s	28 mph / 12.5 m/s	28 mph / 12.5 m/s
Tire Size (Non-Marking Solid)	12.7 x 4-in / 323 x 100-mm	16 x 5-in / 406 x 125-mm	16 x 5-in / 406 x 125-mm	16 x 5-in / 406 x 125-mm	16 x 5-in / 406 x 125-mm
Batteries	4 x 6V 220 amp-hr	4 x 6V, 220 amp-hr	4 x 6V, 220 amp-hr	4 x 6V, 220 amp-hr	4 x 6V, 255 amp-hr
Charger	27 amp	27 amp	27 amp	27 amp	27 amp
Pump	Fixed Displacement Gear	Fixed Displacement Gear	Fixed Displacement Gear	Fixed Displacement Gear	Fixed Displacement Gear
Hydraulic Reservoir	1 gal / 3.8 L	1.25 gal / 4.73 L	1.7 gal / 6.4 L	1.7 gal / 6.4 L	3.2 gal / 12 L
Brakes (on drive wheels)	Multi-Disc Friction	Electric, Friction	Electric, Friction	Electric, Friction	Electric, Friction
Rail Type	QuikFold	Fold Down	Fold Down	Fold Down	Fold Down
Drive	24V AC	24V AC	24V AC	24V AC	24V AC

*Certain weights and dimensions may vary due to options and to compliance with country standards. Specifications may change to meet country standards or with addition of optional equipment.
ES1932i Indoor-only model available, consult factory
1. Dimensions reflect outside measurements.

DAVINCI SERIES - ALL ELECTRIC

AE1932 Scissor Lift

AE1932

Platform Height (Indoor)	19-ft / 5.79-m
Platform Height (Outdoor)	19-ft / 5.79-m
Platform Height — Lowered	38.7-in / 98-cm
Platform Railing Height ¹	44.4-in / 1.28-m
Overall Height	83.2-in / 2.11-m
— With Rails Folded	78.2-in / 1.99-m
Platform Dimensions ²	65.5 x 29.1-in / 1.66 x 74-cm
— Platform Extension	36-in / 91.4-cm
Overall Machine Length	68.7-in / 1.74-m
Overall Machine Width	32-in / 81-cm
Wheelbase	53-in / 1.34-m
Ground Clearance	2.8-in / 7-cm
Platform Capacity (Indoor)	606-lb / 275-kg
Platform Capacity (Outdoor)	606-lb / 275-kg
— Capacity on Deck Extension	265-lb / 120-kg
No. Occupants (Indoor)	2
No. Occupants (Outdoor)	1
Lift/Lower Time	24/26 seconds
Maximum Drive Height (Indoor)	Full Height
Maximum Drive Height (Outdoor)	Full Height
Weight*	3,475-lb / 1,576-kg
Ground Bearing Pressure	150 psi / 10.5-kg/cm ²
Drive Speed—Lowered	4 mph / 6.4 km/h
Drive Speed—Elevated	0.5 mph / 0.8 km/h
Max Tilt Rating	
— Indoor (Side to Side)	1.75 Degrees
— Outdoor (Side to Side)	1.5 Degrees
— Fore and Aft	3.75 Degrees
Gradeability	25%
Turning Radius (Inside)	Zero
Turning Radius (Outside)	66-in / 1.68-m
Max Wind Speed Rating	28 mph / 12.5 m/s
Tire Size (Non-Marking Solid)	12.5 x 4-in / 323 x 100-mm
Battery	Single 24V Lithium Ion, 80 aH
Charger	27 amp
Lift System	Fully Electric
Steer System	Fully Electric
Brakes (On Drive Wheels)	Multi-Disc Friction
Rail Type	QuikFold
Drive	24V AC

*Certain weights and dimensions may vary due to options and to compliance with country standards.

1. Platform railing height with standard QuikFold Rails

2. Dimensions reflect outside measurements.



ERT SERIES

ERT2669 / ERT3369 / ERT4069 / ERT4769 Scissors

	ERT2669	ERT3369	ERT4069	ERT4769
Platform Height	26-ft 2-in / 7.98-m	32-ft 8-in / 9.96-m	40-ft 3-in / 12.3-m	47-ft / 14.3-m
Platform Height — Lowered	4-ft 3-in / 1.3-m	4-ft 9-in / 1.46-m	4-ft 10-in / 1.46-m	5-ft 4-in / 1.62-m
Platform Capacity (Single Extension)	1,500-lb / 680-kg	1,000-lb / 454-kg	800-lb / 363-kg	800-lb / 363-kg
— Capacity on Deck Extension	300-lb / 136-kg	300-lb / 136-kg	300-lb / 136-kg	300-lb / 136-kg
No. Occupants (Indoor/Outdoor)	4/4	4/2	3/2	3/2
Platform Railing Height	44.7-in / 1.14-m	44.7-in / 1.14-m	44.7-in / 1.14-m	44.7-in / 1.14-m
Overall Height	96.7-in / 2.46-m	102.9-in / 2.61-m	103-in / 2.62-m	109.1-in / 2.77-m
Platform Dimensions ¹	130.5 x 63-in / 3.3 x 1.6-m	130.5 x 63-in / 3.3 x 1.6-m	130.5 x 63-in / 3.3 x 1.6-m	130.5 x 63-in / 3.3 x 1.6-m
— Platform Extension	42-in / 1.07-m	42-in / 1.07-m	42-in / 1.07-m	42-in / 1.07-m
Overall Machine Length	139-in / 3.53-m	139-in / 3.53-m	139-in / 3.53-m	139-in / 3.53-m
Overall Machine Width	69.3-in / 1.76-m	69.3-in / 1.76-m	69.3-in / 1.76-m	69.3-in / 1.76-m
Wheelbase	81.3-in / 2.07-m	81.3-in / 2.07-m	81.3-in / 2.07-m	81.3-in / 2.07-m
Ground Clearance	9.5-in / 24-cm	9.5-in / 24-cm	9-in / 22-cm	9-in / 22-cm
Lift/Lower Time	36/28 seconds	42/33 seconds	69/46 seconds	81/55 seconds
Maximum Drive Height	Full Height	Full Height	Full Height	Full Height
Weight (Single Extension w/out Leveling Jacks) ²	8,250-lb / 3,750-kg	9,425-lb / 4,284-kg	10,558-lb / 4,799-kg	15,200-lb / 6,909-kg
Ground Bearing Pressure	40 psi / 2.81 kg/cm ²	40 psi / 2.81 kg/cm ²	44 psi / 3.09 kg/cm ²	56 psi / 3.94 kg/cm ²
Drive Speed—Lowered	3.5 mph / 5.6 km/h	3.5 mph / 5.6 km/h	3.5 mph / 5.6 km/h	3.5 mph / 5.6 km/h
Drive Speed—Elevated	0.5 mph / 0.8 km/h	0.5 mph / 0.8 km/h	0.3 mph / 0.48 km/h	0.3 mph / 0.48 km/h
Max Tilt Rating (Side-to-Side) ³	2.5 Degrees	2.5 Degrees	2.5 Degrees	2.5 Degrees
Max Tilt Rating (Fore/Aft) ³	3 Degrees	3 Degrees	3 Degrees	3 Degrees
Gradeability	40%	35%	35%	35%
Turning Radius (Inside)	83-in / 2.11-m	83-in / 2.11-m	83-in / 2.11-m	83-in / 2.11-m
Turning Radius (Outside)	174.8-in / 4.44-m	174.8-in / 4.44-m	174.8-in / 4.44-m	174.8-in / 4.44-m
Max Wind Speed Rating	28 mph / 12.5 m/s	28 mph / 12.5 m/s	28 mph / 12.5 m/s	28 mph / 12.5 m/s
Tire size (Non-Marking)	26 x 12 Foam-Filled	26 x 12 Foam-Filled	26 x 12 Foam-Filled	26 x 12 Foam-Filled
Batteries	8 x 6V, 225 Ah	8 x 6V, 225 Ah	8 x 6V, 310 Ah	8 x 6V, 375 Ah
Rail Type	Fold Down	Fold Down	Fold Down	Fold Down
Drive (2WD)	AC Electric Drive	AC Electric Drive	AC Electric Drive	AC Electric Drive
Generator Set (Kubota Stage V OC60-E4) ³	6 hp / 4.5 kW	6 hp / 4.5 kW	6 hp / 4.5 kW	6 hp / 4.5 kW
Hydraulic Reservoir	13.2 gal / 50 L	13.2 gal / 50 L	13.2 gal / 50 L	13.2 gal / 50 L

*Certain options or country standards increase weight.

Specifications may change without notice to meet country standards or with addition of optional equipment.

1. Dimensions reflect inside measurements.

2. At max height

3. Optional configuration

RT SERIES (69-IN WIDE)

RT2669 / RT3369 / RT4069 / RT4769 Scissors

	RT2669	RT3369	RT4069	RT4769
Platform Height	26-ft 2-in / 7.98-m	32-ft 8-in / 9.96-m	40-ft 3-in / 12.3-m	47-ft / 14.3-m
Platform Height — Lowered	4-ft 3-in / 1.3-m	4-ft 9-in / 1.46-m	4-ft 10-in / 1.46-m	5-ft 4-in / 1.62-m
Platform Capacity (Single Extension)	1,500-lb / 680-kg	1,000-lb / 454-kg	800-lb / 363-kg	800-lb / 363-kg
— Capacity on Deck Extension	300-lb / 136-kg	300-lb / 136-kg	300-lb / 136-kg	300-lb / 136-kg
No. Occupants (Indoor/Outdoor)	4/4	4/2	3/2	3/2
Platform Railing Height	44.7-in / 1.14-m	44.7-in / 1.14-m	44.7-in / 1.14-m	44.7-in / 1.14-m
Overall Height	96.7-in / 2.46-m	102.9-in / 2.61-m	103-in / 2.62-m	109.1-in / 2.77-m
Platform Dimensions ¹	130.5 x 63-in / 3.3 x 1.6-m	130.5 x 63-in / 3.3 x 1.6-m	130.5 x 63-in / 3.3 x 1.6-m	130.5 x 63-in / 3.3 x 1.6-m
— Platform Extension	42-in / 1.07-m	42-in / 1.07-m	42-in / 1.07-m	42-in / 1.07-m
Overall Machine Length	139-in / 3.53-m	139-in / 3.53-m	139-in / 3.53-m	139-in / 3.53-m
Overall Machine Width	69.3-in / 1.76-m	69.3-in / 1.76-m	69.3-in / 1.76-m	69.3-in / 1.76-m
Wheelbase	81.3-in / 2.07-m	81.3-in / 2.07-m	81.3-in / 2.07-m	81.3-in / 2.07-m
Ground Clearance	9.5-in / 24-cm	9.5-in / 24-cm	9-in / 22-cm	9-in / 22-cm
Lift/Lower Time	32/37 seconds	40/40 seconds	50/48 seconds	65/60 seconds
Maximum Drive Height	Full Height	Full Height	Full Height	Full Height
Weight (Single Extension w/out Leveling Jacks)*	8,090-lb / 3,677-kg	9,080-lb / 4,127-kg	10,540-lb / 4,791-kg	15,000-lb / 6,818-kg
Ground Bearing Pressure	40 psi / 2.81 kg/cm ²	40 psi / 2.81 kg/cm ²	44 psi / 3.09 kg/cm ²	56 psi / 3.94 kg/cm ²
Drive Speed—Lowered	3.5 mph / 5.6 km/h	3.5 mph / 5.6 km/h	3.0 mph / 4.82 km/h	3.0 mph / 4.82 km/h
Drive Speed—Elevated	0.5 mph / 0.8 km/h	0.5 mph / 0.8 km/h	0.3 mph / 0.48 km/h	0.3 mph / 0.48 km/h
Max Tilt Rating (Side-to-Side) ²	2.5 Degrees	2.5 Degrees	2.5 Degrees	2.5 Degrees
Max Tilt Rating (Fore/Aft) ²	3 Degrees	3 Degrees	3 Degrees	3 Degrees
Gradeability	40%	35%	35%	35%
Turning Radius (Inside)	83-in / 2.11-m	83-in / 2.11-m	83-in / 2.11-m	83-in / 2.11-m
Turning Radius (Outside)	174.8-in / 4.44-m	174.8-in / 4.44-m	174.8-in / 4.44-m	174.8-in / 4.44-m
Max Wind Speed Rating	28 mph / 12.5 m/s	28 mph / 12.5 m/s	28 mph / 12.5 m/s	28 mph / 12.5 m/s
Tire size	26 x 12 Foam-Filled	26 x 12 Foam-Filled	26 x 12 Foam-Filled	26 x 12 Foam-Filled
Rail Type	Fold Down	Fold Down	Fold Down	Fold Down
Drive	4WD Hydrostatic	4WD Hydrostatic	4WD Hydrostatic	4WD Hydrostatic
Dual Fuel Engine	Kubota WG972-GL-E4 31 hp / 23.2 kW	Kubota WG972-GL-E4 31 hp / 23.2 kW	Kubota WG972-GL-E4 31 hp / 23.2 kW	Kubota WG972-GL-E4 31 hp / 23.2 kW
Diesel Engine	Kubota D1305-E4B 24.8 hp / 18.5 kW	Kubota D1305-E4B 24.8 hp / 18.5 kW	Kubota D1305-E4B 24.8 hp / 18.5 kW	Kubota D1305-E4B 24.8 hp / 18.5 kW
Fuel Tank Capacity	10 gal / 38 L	10 gal / 38 L	10 gal / 38 L	10 gal / 38 L
Hydraulic Reservoir	13.2 gal / 50 L	13.2 gal / 50 L	13.2 gal / 50 L	13.2 gal / 50 L

*Certain options or country standards increase weight.

Specifications may change without notice to meet country standards or with addition of optional equipment.

1. Dimensions reflect inside measurements.

2. At max height

RT LARGE ROUGH TERRAIN SERIES (94-IN WIDE)

RT3394 / RT4394 / RT5394 Scissors

	RT3394	RT4394	RT5394
Platform Height—Elevated	33-ft / 10.06-m	43-ft / 13.11-m	53-ft / 16.5-m
Platform Height—Lowered	5-ft 3.57-in / 1.97-m	6-ft 5-in / 1.84-m	7-ft / 2.13-m
No. Occupants	6	6	6
Platform Railing Height	43.5-in / 1.1-m	43.5-in / 1.1-m	43.5-in / 1.1-m
Overall Height	9-ft 1-in / 2.8-m	9-ft 10-in / 3.0-m	10-ft 5-in / 3.2-m
—With Rails Lowered	6-ft 5.75-in / 1.97-m	7-ft 2.4-in / 2.19-m	7-ft 9-in / 2.36-m
Platform Dimensions ¹	70.5 x 149.8-in / 1.8 x 3.8-m	70.5 x 149.8-in / 1.8 x 3.8-m	70.5 x 149.8-in / 1.8 x 3.8-m
Platform Extension	4-ft / 1.22-m	4-ft / 1.22-m	4-ft / 1.22-m
Overall Length	16-ft / 4.9-m	16-ft / 4.9-m	16-ft / 4.9-m
Overall Width	7-ft 9-in / 2.36-m	7-ft 9-in / 2.36-m	7-ft 7-in / 2.31-m
Wheelbase	9-ft 9-in / 2.97-m	9-ft 9-in / 2.97-m	9-ft 9-in / 2.97-m
Ground Clearance	13.6-in / 34.5-cm	13.6-in / 34.5-cm	12-in / 30-cm
Platform Capacity	2,250-lb / 1,020-kg	1,500-lb / 680-kg	1,500-lb / 680-kg
—Capacity on Extension	500-lb / 227-kg	500-lb / 227-kg	500-lb / 227-kg
—Capacity w/Dual Extensions	2,000-lb / 907-kg	1,250-lb / 567-kg	1,250-lb / 567-kg
Lift/Lower Time	35/37 seconds	45/47 seconds	59/55 seconds
Maximum Drive Height	Full Height	Full Height	32-ft / 9.75-m
Weight w/One Extension*	11,820-lb / 5,372-kg	15,210-lb / 6,914-kg	17,110-lb / 7,761-kg
Ground Bearing Pressure**	73 psi / 5.1-kg/cm ²	83 psi / 5.8-kg/cm ²	90 psi / 6.3-kg/cm ²
Drive Speed (Lowered)	3.5 mph / 4.8 km/h	3.5 mph / 4.8 km/h	3.5 mph / 5.6 km/h
Drive Speed (Elevated)	0.5 mph / 0.8 km/h	0.5 mph / 0.8 km/h	0.5 mph / 0.8 km/h
Tilt Rating (Side-to-Side)	3 Degrees	3 Degrees	1.5 Degrees
Tilt Rating (Side-to-Side/Fore-Aft)	5 Degrees	5 Degrees	1.5 Degrees
Gradeability	45%	45%	40%
Turning Radius (Inside)	8-ft 10.5-in / 2.71-m	8-ft 10.5-in / 2.71-m	9-ft / 2.74-m
Turning Radius (Outside)	19-ft 5.5-in / 5.93-m	19-ft 5.5-in / 5.93-m	19-ft 9-in / 6.02-m
Max Wind Speed Rating	28 mph / 12.5 m/s	28 mph / 12.5 m/s	28 mph / 12.5 m/s
Tire Size/Type	12 x 16.5 Foam-Filled	12 x 16.5 Foam-Filled	12 x 16.5 Foam-Filled
Axle Oscillation	8-in / 20-cm	8-in / 20-cm	8-in / 20-cm
Brakes—4 Wheel	Spring Applied	Spring Applied	Spring Applied
Dual Fuel Engine	Kubota W6972 31 hp / 23 kW	Kubota W6972 31 hp / 23 kW	Kubota W6972 31 hp / 23 kW
Diesel Engine	Kubota D1305 24.8 hp / 18.5 kW	Kubota D1305 24.8 hp / 18.5 kW	Kubota D1305 24.8 hp / 18.5 kW
Fuel Tank Capacity	22 gal / 83.3 L	22 gal / 83.3 L	22 gal / 83.3 L
Hydraulic Reservoir	32 gal / 121.42 L	32 gal / 121.42 L	32 gal / 121.42 L

*Certain options or country standards increase weight.

**Ground bearing pressure applies to standard tires.

Specifications may change without notice to meet country standards or with addition of optional equipment.

1. Dimensions reflect inside measurements.

1230ES

Electric Vertical Mast Lift

1230ES

Platform Height — Elevated	12-ft / 3.66-m
Platform Height — Lowered	1-ft 10-in / 0.56-m
Platform Railing Height	3-ft 7-in / 1.10-m
Overall Height	5-ft 5-in / 1.66-m
Platform Dimensions ¹	27 x 33-in / 0.68 x .84-m
Overall Length	54-in / 1.36-m
Overall Width	30-in / 0.76-m
Wheelbase	3-ft 5-in / 1.04-m
Ground Clearance	2.6-in / 66-cm
Platform Capacity	500-lb / 227-kg
Lift/Lower Time (No Load)	15/21 seconds
Lift/Lower Time (Rated Load)	17/25 seconds
Maximum Drive Height	Full Height
Weight	1,775-lb / 805-kg
Ground Bearing Pressure	123 psi / 8.65-kg/cm ²
Drive Speed — Lowered	3 mph / 4.8 km/h
Drive Speed — Elevated	0.5 mph / 0.8 km/h
Gradeability	25%
Turning Radius (Inside)	4.4-in / 11.2-cm
Turning Radius (Outside)	4-ft 10-in / 1.46-m
Max Wind Speed Rating	0 mph / 0 m/s - Indoor Use Only
Tire Size/Type	100 x 323 Non-Marking Solid
Brakes (On Drive Wheels)	Electric, Friction
Batteries	4 x 6V, 220 amp-hr
Charger	20 Amp Automatic (120V/240V - 50/60 HZ)
Drive	24V Electric
Hydraulic Reservoir	1.88 gal / 7.1 L

NOTE: Rated for indoor use only

1. Dimensions reflect inside measurements

ACCESSMASTER® MANUALLY PROPELLED Vertical Personnel Lifts

AM Series (With Outriggers)	25AM	30AM	38AM
Working Height	31-ft / 9.45-m	35 -ft 7 in / 10.88-m	44-ft / 13.4-m
Platform Height	25-ft 2-in / 7.67-m	29 ft 7 in. / 9.05-m	38-ft / 11.58-m
Platform Capacity*	350-lb / 160-kg	300-lb / 136-kg	300-lb / 136-kg
Standard Platform	26 x 28-in / 66 x 71-cm	26 x 28-in / 66 x 71-cm	26 x 28-in / 66 x 71-cm
Overall Height	77-in / 1.95-m	78-in / 1.98-m	104.5-in / 2.65-m
Overall Width	29.5-in / 0.75-m	29.5-in / 0.75-m	29.5-in / 0.75-m
Overall Length	55-in / 1.40-m	58-in / 1.47-m	61-in / 1.55-m
Overall Length—Without Battery Pack	47-in / 1.19-m	47-in / 1.19-m	47-in / 1.19-m
Overall Height—Tilted Back	N/A	N/A	77.5-in / 1.97-m
Overall Length—Tilted Back	N/A	N/A	119-in / 3.02-m
Ground Entry Height	16.5-in / 0.42 -m	16.5-in / 0.42 -m	16.5 -in / 0.42-m
Outrigger Footprint Length	68.1-in / 1.57-m	79-in / 2-m	85.8-in / 2.13-m
Outrigger Footprint Width	62-in / 1.57-m	72-in / 1.83-m	80.5-in / 2.0-m
Distance to Wall—Front	6-in / 15.5-cm	9.5-in / 24-cm	15-in / 38-cm
Distance to Wall—Side	11.5-in / 28.9-cm	20.5-in / 52-cm	24-in / 61-cm
Weight**—AC	825-lb / 374-kg	1,030-lb / 467-kg	1,265-lb / 574-kg
Weight**—DC	905-lb / 411-kg	1,110-lb / 504-kg	1,395-lb / 633-kg
Rear Wheels	10 x 2-in / 25 x 5-cm	10 x 2-in / 25 x 5-cm	10 x 2-in / 25 x 5-cm
Front Caster Wheels	6 x 2-in / 15 x 5-cm	6 x 2-in / 15 x 5-cm	6 x 2-in / 15 x 5-cm
Ground Bearing Pressure	49 psi / 3.5-kg/cm ²	49 psi / 3.5-kg/cm ²	49 psi / 3.5-kg/cm ²
Lift/Lower Time	62/37 seconds	72/35 seconds	120/50 seconds
Batteries	12 V DC/93 Amp hr	12 V DC/93 Amp hr	12 V DC/93 Amp hr
Max Outrigger Load	510-lb	510-lb	510-lb
Max Outrigger Ground Bearing Pressure	49 psi / 3.5-kg/cm ²	49 psi / 3.5-kg/cm ²	49 psi / 3.5-kg/cm ²
Front to Front Gradability Max	10 Degrees	9 Degrees	8 Degrees
Side to Side Gradability Max	11.5 Degrees	8.4 Degrees	7.1 Degrees
Max Wind Speed Rating	0 mph / 0 m/s - Indoor Use Only	0 mph / 0 m/s - Indoor Use Only	0 mph / 0 m/s - Indoor Use Only

* Standard Platform.

** Certain options or country standards increase weight.

Specifications may change to meet country standards or with addition of optional equipment.

E18 SERIES

Mobile Vertical Mast Lifts

	NEW E18MML	NEW E18MCL
Platform Height—Elevated (Indoor)	18-ft / 5.5-m	18-ft / 5.5-m
Platform Height - Elevated (Outdoor)	N/A	13-ft / 4-m
Platform Capacity*	400-lb / 181-kg	400-lb / 181-kg
—Capacity on Deck Extension*	N/A	250-lb / 113-kg
—Capacity on Work Tray*	100-lb / 45-kg	N/A
No. Occupants (Indoor)	1	1
No. Occupants (Outdoor)	N/A	1
Overall Height	78-in / 1.98-m	78-in / 1.98-m
Platform Dimensions*	29.5 x 28-in / 75 x 71-cm	30 x 51-in (Extracted) / 76 x 130-cm
—Platform Extension*	N/A	19.5-in / 50-cm
Overall Machine Length	32-in / 81-cm	32-in / 81-cm
Overall Machine Width	30-in / 76-cm	30-in / 76-cm
Platform Entry Height	18.5-in / 47-cm	18.5-in / 47-cm
Wheelbase	41.4-in / 1.05-m	41.4-in / 1.05-m
Ground Clearance	2.5-in / 6.35-cm	2.5-in / 6.35-cm
Lift/Lower Time	23/23	23/23
Maximum Drive Height (Indoor)	Full Height	Full Height
Maximum Drive Height (Outdoor)	N/A	13-ft / 4-m
Weight**	1,950-lb / 885-kg	1,950-lb / 885-kg
Ground Bearing Pressure	TBD	TBD
Drive Speed—Lowered	2.5 mph / 4 km/h	2.5 mph / 4 km/h
Drive Speed—Elevated	0.5 mph / .8 km/h	0.5 mph / .8 km/h
Gradeability	30%	30%
Turning Radius (Inside)	Zero	Zero
Turning Radius (Outside)	48-in / 1.2-m	55-in / 1.4-m
Max Wind Speed Rating	0 mph / 0 m/s - Indoor Use Only	28 mph / 12.5 m/s
Tire Size (Rear) - Non-Marking	10 x 3-in	10 x 3-in
Tire Size (Front) - Non-Marking	8-in Casters	8-in
Batteries	Four 6V - 220 AH	Four 6V - 220 AH
Charger	27 amp	27 amp
Brakes (On Drive Wheels)	Electric	Electric
Drive	Drive 4 Brush Direct Electric Drive (Planetary Gear)	Drive 4 Brush Direct Electric Drive (Planetary Gear)

*Based on Standard Configuration

**Certain weights and dimensions may vary due to options and to compliance with country standards.

ECOLIFT™ SERIES

Non-Powered Vertical Lifts

	EcoLift 50	EcoLift 70
Working Height	11-ft / 3.50-m	13-ft / 3.96-m
Platform Height	5-ft / 1.50-m	7-ft / 2.20-m
Stowed Height	61-in / 1.55-m	76-in / 1.94-m
Stowed Width	28-in / 0.7-m	29-in / 0.74-m
Stowed Length	39-in / 0.98-m	50.3-in / 1.28-m
Platform Size	28 x 24-in / .72 x .6-m	33 x 25.5-in / 0.85 x 0.65-m
Rated Capacity	330-lb / 150-kg	330-lb / 150-kg
Weight	432-lb / 196-kg	703-lb / 319-kg
Max Ground Bearing Pressure Front	160 psi / 11.2-kg/cm ²	170 psi / 11.9-kg/cm ²
Max Ground Bearing Pressure Rear	168 psi / 11.8-kg/cm ²	175 psi / 12.3-kg/cm ²
Max Wind Speed Rating	0 mph / 0 m/s - Indoor Use Only	0 mph / 0 m/s - Indoor Use Only

Push-Around Mast Lifts

	830P	1030P	NEW 1230P
Working Height	14-ft 2-in / 4.32-m	16-ft 2-in / 5.11-m	17-ft 4-in / 5.50-m
Platform Height	8-ft 2-in / 2.5-m	10-ft 2-in / 3.10-m	11-ft 4-in / 3.50-m
Stowed Height	61.4-in / 1.56-m	6-ft 1-in / 1.85-m	77-in / 1.95-m
Platform Entry Height	14-in / 36-cm	29-in / 74-cm	15-in / 39-cm
Platform Size	33.5-in x 28-in / .85-m x .72-m	59-in x 30-in / 1.50-m x 0.76-m	33-in x 28-in / 0.85-m x 0.72-m
Overall Vehicle Length	47-in / 1.19-m	64-in / 1.63-m	47-in / 1.205-m
Overall Vehicle Width	29.5-in / 75-cm	31-in / 0.79-m	30-in / 0.76-m
Platform Capacity	440-lb / 200-kg	550-lb / 249-kg	440-lb / 200-kg
Weight	714-lbs / 324-kg	805-lb / 365-kg	1,058-lb / 432-kg
Max Ground Bearing Pressure	174 psi / 12.23 kg/cm ²	174 psi / 12.23 kg/cm ²	TBD
Batteries	12V AGM	12V AGM	12V AGM
Battery Charger	Automatic 110V-240V Charger	Automatic 110V-240V Charger	Automatic 110V, 12V DC, 6A
Max Wind Speed Rating	0 mph / 0 m/s - Indoor Use Only	0 mph / 0 m/s - Indoor Use Only	0 mph / 0 m/s - Indoor Use Only

MSP SERIES

Mobile Stock Pickers

	10MSP	NEW E18MSP
Platform Height—Elevated (Indoor)	10-ft / 3.05-m	18-ft / 5.5-m
Platform Height - Elevated (Outdoor)	N/A	N/A
Platform Capacity*	350-lb / 159-kg	400-lb / 181-kg
—Capacity on Deck Extension*	N/A	N/A
—Capacity on Work Tray*	250-lb / 113-kg	100-lb / 45-kg
No. Occupants (Indoor)	1	1
No. Occupants (Outdoor)	N/A	N/A
Overall Height	57-in / 145-cm	78-in / 1.98-m
Platform Dimensions*	27 x 20-in / 69 x 49.5-cm	29.5 x 28-in / 75 x 71-cm
—Platform Extension*	N/A	N/A
Overall Machine Length	61-in / 155-cm	32-in / 81-cm
Overall Machine Width	32.5-in / 82.5-cm - With Bumper	30-in / 76-cm
Platform Entry Height	13.75-in / 35-cm	18.5-in / 47-cm
Wheelbase	46.4-in / 1.18-m	41.4-in / 1.05-m
Ground Clearance	2-in / 5-cm	2.5-in / 6.35-cm
Lift/Lower Time	13/13 seconds	23/23
Maximum Drive Height (Indoor)	Full Height	Full Height
Maximum Drive Height (Outdoor)	N/A	N/A
Weight**	1,100-lb / 499-kg	1,950-lb / 885-kg
Ground Bearing Pressure	TBD	TBD
Drive Speed—Lowered	5.0 mph / 8.0 km/h	2.5 mph / 4 km/h
Drive Speed—Elevated	0.5 mph / .8 km/h	0.5 mph / .8 km/h
Gradeability	15%	30%
Turning Radius (Inside)	Zero	Zero
Turning Radius (Outside)	65-in / 1.65-m	48-in / 1.2-m
Max Wind Speed Rating	0 mph / 0 m/s - Indoor Use Only	0 mph / 0 m/s - Indoor Use Only
Tire Size (Rear) - Non-Marking	12.62 x 4-in (32 x 10-cm)	10 x 3-in
Tire Size (Front) - Non-Marking	8 x 2.5-in (20 x 6-cm) Caster Wheels	8-in Casters
Batteries	4 Sealed 210 amp-hr Maintenance Free (AGM)	Four 6V - 220 AH
Charger	25 amp	27 amp
Brakes (On Drive Wheels)	Electric	Electric
Drive	Drive 4 Brush Direct Electric Drive (Planetary Gear)	Drive 4 Brush Direct Electric Drive (Planetary Gear)

*Based on Standard Configuration

**Certain weights and dimensions may vary due to options and to compliance with country standards.

Mobile Elevating Work Platforms

Booms

TOUCAN[®] SERIES

Mast-Style Boom Lifts

	20E	26E	32E
Platform Height	20-ft 3-in / 6.2-m	26-ft 6-in / 8.10-m	32-ft 3-in / 9.83-m
Horizontal Outreach	6-ft 5-in / 1.97-m	8-ft 8-in / 2.64-m	14-ft 9-in / 4.55-m
Up and Over Height	16-ft 7-in / 5.05-m	21-ft 4-in / 6.51-m	22-ft 8-in / 6.95-m
Swing	345 Degrees Non-Continuous	345 Degrees Non-Continuous	345 Degrees Non-Continuous
Platform Capacity	500-lb / 227-kg	500-lb / 227-kg	500-lb / 227-kg
Platform Rotator	N/A	N/A	120 Degrees Hydraulic
Jib (Range of Articulation)	112 Degrees (+45, -67) Vertical	127 Degrees (+66, -61) Vertical	125 Degrees Vertical/10- to 15-ft Telescopic
Platform Size	32 x 36-in / 0.81 x 0.90-m	28 x 36-in / 0.7 x 0.9-m	27.5 x 41.3-in / 0.70 x 1.05-m
Overall Width	3-ft 3-in / 0.99-m	3-ft 3-in / 1.2-m	3-ft 9-in / 1.20-m
Tailswing	6.7-in / 17-cm	4.7-in / 12-cm	5.9-in / 15-cm
Height Stowed	6-ft 5-in / 1.99-m	6-ft 5-in / 1.99-m	6-ft 5-in / 1.99-m
Stowed Length (Drop Bar)	6-ft 9-in / 2.10-m	9-ft 3-in / 2.82-m	12-ft / 3.65-m
Wheelbase	3-ft 9-in / 1.20-m	3-ft 9-in / 1.20-m	5-ft 3-in / 1.6-m
Ground Clearance	3.9-in / 10-cm	3.9-in / 10-cm	3.9-in / 10-cm
Weight*	4,980-lb / 2,260-kg	6,900-lb / 3,130-kg	10,140-lb / 4,600-kg
Ground Bearing Pressure**	255 psi / 17.9-kg/cm ²	319 psi / 22.4-kg/cm ²	185 psi / 13-kg/cm ²
Drive Speed (Lowered)	3.4 mph / 5.5 km/h	3.4 mph / 5.5 km/h	3.4 mph / 5.5 km/h
Drive Speed (Elevated)	.47 mph / .76 km/h	.47-.25 mph / .76-.41 km/h ¹	.47 mph / .76 km/h
Gradeability	25%	25%	25%
Turning Radius (Inside)	1-ft 8-in / 0.55-m	1-ft 8-in / 0.55-m	2-ft 5-in / 0.75-m
Turning Radius (Outside)	6-ft 5-in / 1.99-m	6-ft 5-in / 1.99-m	8-ft 5-in / 2.6-m
Max Wind Speed Rating	28 mph / 12.5 m/s	28 mph / 12.5 m/s	28 mph / 12.5 m/s
Tire Size/Type	16 x 5 x 10.5 Non-Marking	12.5 x 406 Non-Marking	18 x 7 x 12.12 Non-Marking
Electrical System	24V DC	24V DC	48V DC
Batteries	4x6V 213Ah AGM	260 amp-hr AGM	260 amp-hr
Battery Charger	27 amps	27 amps	20 amps
Drive Motors	2 — AC	2 — AC	2 — AC
Brakes	Spring Applied Disc	Spring Applied Disc	Spring Applied Disc
Hydraulic Motor/Pump	6.4 hp/ 3.3 cc/rev	6.4 hp/ 5.2 cc/rev	6.4 hp/ 5.2 cc/rev
Hydraulic Reservoir	1.98 gal / 7.5 L	2.38 gal / 9 L	5.8 gal / 22 L

*Certain options or country standards increase weight.

**Ground bearing pressure applies to standard tires.

1. .47 mph up to 23-ft 7.5-in in platform height (with jib fully raised); .25 mph above 23-ft 7.5-in in platform height (with jib fully raised):

20E

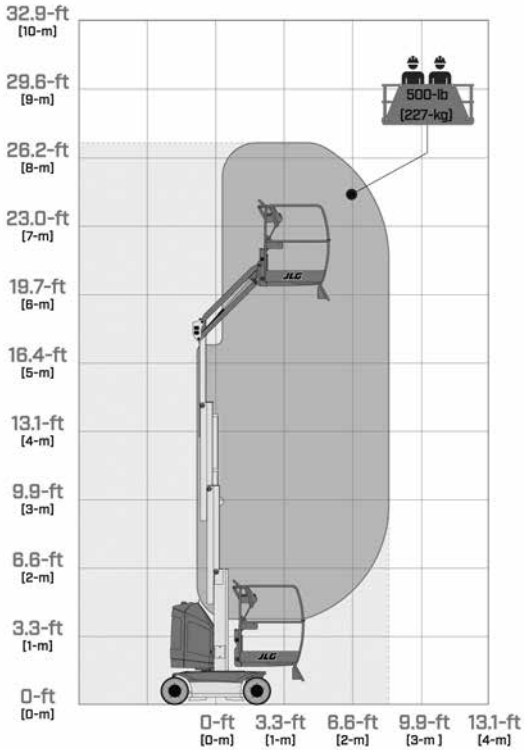

26E

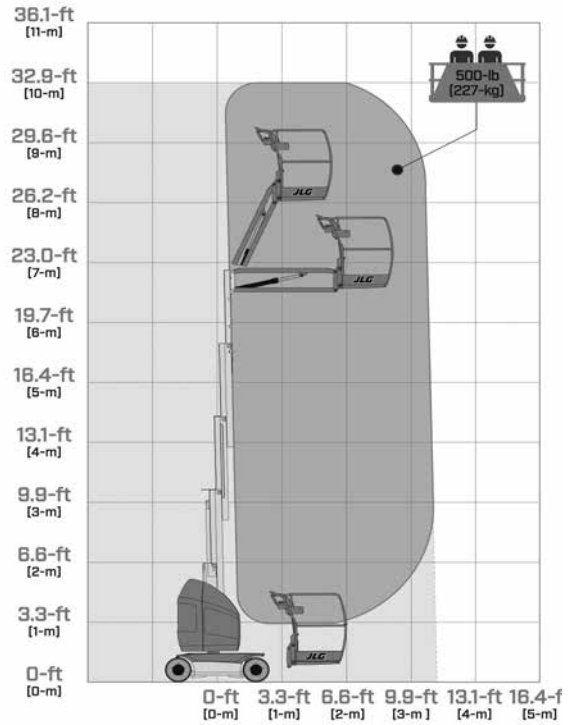

32E

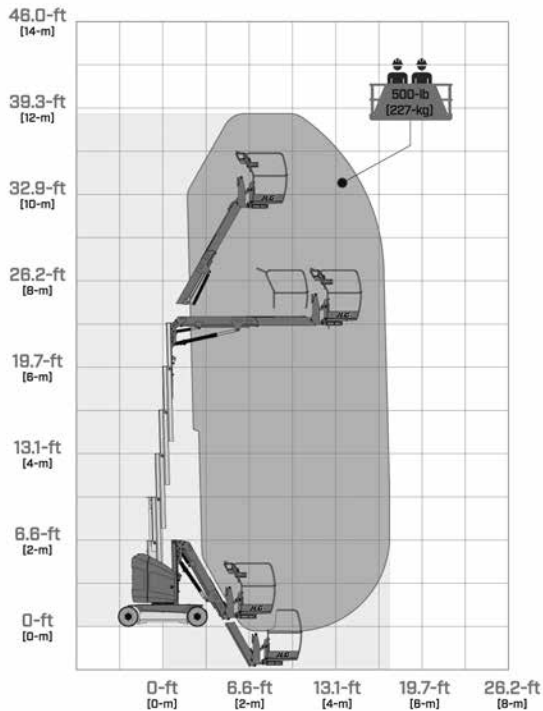

SPECIAL FEATURES INCLUDE:

- Compact dimensions for accessing hard-to-reach areas.
- Versatile articulating jib provides up to 14-ft 6-in (4.42-m) up and over reach.
- 345 degree rotating mast for unmatched positioning capabilities.
- Platform rotator (standard on 32E).
- Capacity for two workers and supplies.
- Drive through doorways and down narrow aisles.
- Navigate around multiple obstacles on the ground and in the air.
- Long lasting, environmentally friendly electric power.

Compact Crawler Series

	X430AJ	X500AJ	X540AJ	X600AJ*	X660SJ	X770AJ	X1000AJ
Platform Height	43-ft 6-in / 13.30-m	49-ft / 14.95-m	54-ft / 16.46-m	59-ft 3-in / 18.05-m	65-ft 7-in / 20-m	77-ft 5-in / 23.60-m	100-ft / 30.48-m
Horizontal Outreach	21-ft 7-in - 6.60-m	23-ft / 7.00-m	24-ft / 7.32-m	30-ft / 9.1-m	39-ft / 11.9-m	43-ft / 13.1-m	54-ft 2-in / 16.50-m
Swing	360 Degrees Non-continuous	360 Degrees Non-continuous	360 Degrees Non-continuous	360 Degrees Non-continuous	360 Degrees Non-continuous	360 Degrees Non-continuous	360 Degrees Non-continuous
Max. Platform Capacity	500-lb / 227-kg	500-lb / 227-kg	500-lb / 227-kg	500-lb / 227-kg	500-lb / 227-kg	500-lb / 227-kg	500-lb / 227-kg
Platform Rotation	124 Degrees (+/-62)	124 Degrees (+/-62)	124 Degrees (+/-62)	124 Degrees (+/-62)	124 Degrees (+/-62)	124 Degrees (+/-62)	180 Degrees (+85/-95)
Jib (Range of Articulation)	89 Degrees (0/-89)	89 Degrees (0/-89)	89 Degrees (0/-89)	89 Degrees (0/-89)	89 Degrees (0/-89)	89 Degrees (0/-89)	180 Degrees (+85/-95)
Platform Size	58 x 30-in / 1.47 x 0.76-m	58 x 30-in / 1.47 x 0.76-m	55 x 30.4-in / 1.4 x 0.77-m	55 x 31-in / 1.4 x 0.77-m	51.5 x 25.5-in / 1.31 x 0.65-m	58 x 30-in / 1.47 x 0.76-m	63 x 28-in / 1.60 x 0.71-m
Overall Width	29-in / 75-cm	31-in / 78-cm	30.4-in / 77-m	31-in / 78-cm	35-in / 89-cm	39-in / 99-cm	47-in / 119-m
Stowed Height	6-ft 6-in / 1.98-m	6-ft 6-in / 1.98-m	6-ft 7-in / 1.99-m	6-ft 7-in / 1.99-m	6-ft 6-in / 1.98-m	6-ft 6-in / 1.98-m	6-ft 6-in / 1.98-m
Outrigger Footprint	9-ft 8-in x 9-ft 8-in / 3.0 x 3.0-m	10-ft 5-in x 10-ft 5-in / 3.17 x 3.17-m	9-ft 7-in x 9-ft 7-in / 2.9-m x 2.9-m	9-ft 7-in x 9-ft 7-in / 2.9-m x 2.9-m	14-ft 1-in x 13-ft 4-in / 4.27-m x 4.08-m	14-ft 6-in x 14-ft 3-in / 4.41 x 4.31-m	18-ft 2-in x 16-ft 5-in / 5.49 x 5-m
Outrigger Footprint - Narrow	N/A	N/A	N/A	N/A	18-ft 10-in x 7-ft 11-in / 5.73-m x 2.41-m	19-ft 2-in x 9-ft 3-in / 5.84 x 2.81-m	22-ft 2-in x 12-ft 2-in / 6.71 x 3.71-m
Stowed Length	13-ft 2-in / 4.02-m	14-ft 10-in / 4.53-m	16-ft 7-in / 5.1-m	16-ft 5-in / 5.01-m	21-ft 11-in / 6.44-m	20-ft 9-in / 6.34-m	21-ft 3-in / 6.48-m
Without Platform	11-ft 2-in / 3.40-m	13-ft 8-in / 4.16-m	14-ft 6-in / 4.4-m	14-ft 5-in / 4.4-m	19-ft 1-in / 5.82-m	19-ft 7-in / 5.98-m	19-ft 3-in / 5.80-m
Track Length	4-ft 1-in / 1.24-m	4-ft 1-in / 1.24-m	4-ft 10-in / 1.5-m	4-ft 10-in / 1.47-m	5-ft 7-in / 1.71-m	6-ft 10-in / 2.08-m	6-ft 10-in / 2.08-m
Weight**	4,392-lb / 1,992-kg	5,071 lb / 2,300-kg	6,239-lbs / 2,830-kg	6,548-lbs / 2,970-kg	7,273 lb / 3,350-kg	9,665 lb / 4,385-kg	16,790 lb / 7,616-kg
Ground Bearing Pressure							
—Outriggers	34.1 psi / 2.40 kg/cm ²	35.53 psi / 2.49 kg/cm ²	36 psi / .62 kg/cm ²	44.09 psi / 3.09 kg/cm ²	79.7psi / 5.6 km/cm ²	64.1 psi / 4.50 kg/cm ²	58 psi / 4.1 kg/cm ²
—Tracks	8.20 psi / 0.58 kg/cm ²	9.72 psi / .68 kg/cm ²	8.8 psi / .62 kg/cm ²	9.28 psi / .65 kg/cm ²	9.08psi / .63 kg/cm ²	7.7 psi / 0.54 kg/cm ²	11.3 psi / 0.79 kg/cm ²
Drive Speed	0.87 mph / 1.4 km/h	0.8 mph / 1.3 km/h	1.6 mph / 2.5 km/h	1.6 mph / 2.5 km/h	1.2 mph / 2.0 km/h	0.7 mph / 1.2 km/h	0.8 mph / 1.3 km/h
Gradeability	28%	28%	28%	28%	40%	28%	28%
Max Wind Speed Rating	28 mph / 12.5 m/s	28 mph / 12.5 m/s	28 mph / 12.5 m/s	28 mph / 12.5 m/s	28 mph / 12.5 m/s	28 mph / 12.5 m/s	28 mph / 12.5 m/s
Engine	Honda iGX390 11.7 hp / 8.7 kW	Honda iGX390 11.7 hp / 8.7 kW	Diesel Kubota 14.5 hp / 10.81 Kw	Diesel Kubota Z602 19.5 hp / 14.5 kW	Diesel Kubota Z602 14.5 HP / 10.8kW	Diesel Kubota D902 21.6 hp / 16.1 kW	Diesel Kubota D902 21.6 hp / 16.1 kW
Electric System (Optional)	100Ah 36V Lithium-Ion	100Ah 48V Lithium-Ion	120Ah 64V Lithium-Ion	120Ah 64V Lithium-Ion	120Ah 51.4V Lithium-Ion	100Ah 76V Lithium-Ion	150Ah 76V Lithium-Ion
Bi-Energy Option Available	No	No	Yes	Yes	Yes	Yes	Yes
Fuel Tank Capacity (Diesel)	1.4 gal. / 5.3 L	1.5 gal. / 5.9 L	4 gal / 15/5 L	4 gal / 15/5 L	7.4 gal. / 28-L	5 gal. / 19-L	6.6 gal. / 25-L
AC Motor	120V 60 Hz / 1.2 kW	120V 60 Hz / 1.2 kW	120V 60 Hz / 1.2 kW	120V 60 Hz / 1.2 kW	120V 60 Hz / 1.2 kW	120V 60 Hz / 1.2 kW	120V 60 Hz / 1.2 kW
Outrigger Pad Diameter	11.8-in / 30-cm	11.8-in / 30-cm	11.8-in / 30-cm	11.8-in / 30-cm	9-in / 23-cm	11.8-in / 30-cm	15.7-in / 40-cm

* Specifications reflect refreshed X600AJ, starting production early 2024. Previous X600AJ models may be available - consult factory for specifications & availability.

**Certain options or country standards increase weight.

Bi-Energy:

This option equips the machine with both the Lithium-Ion Battery and Diesel Engine shown above, which allows the operator to choose the best power source to run independently.

X430AJ

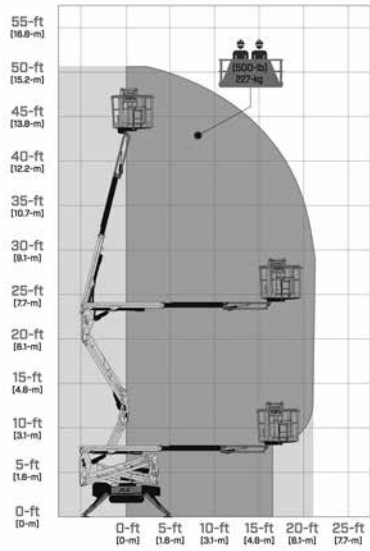

X500AJ

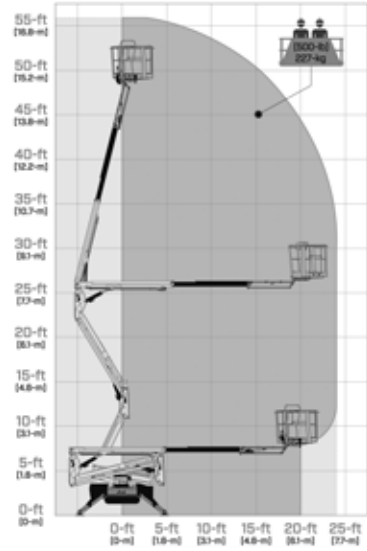

X540AJ

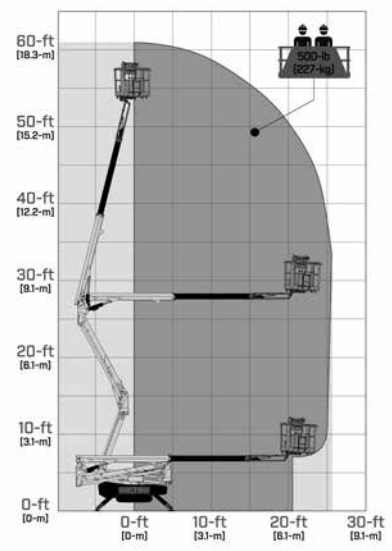

X600AJ

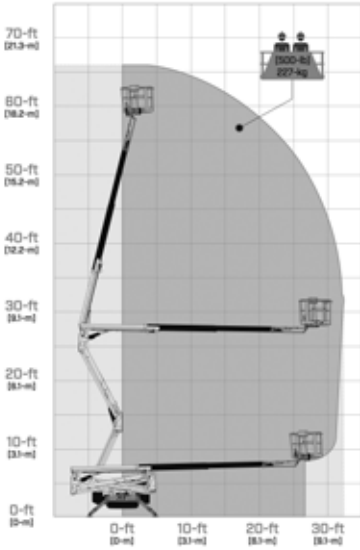

X660SJ

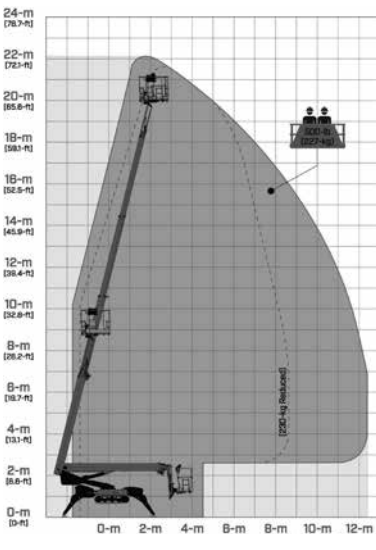

X770AJ

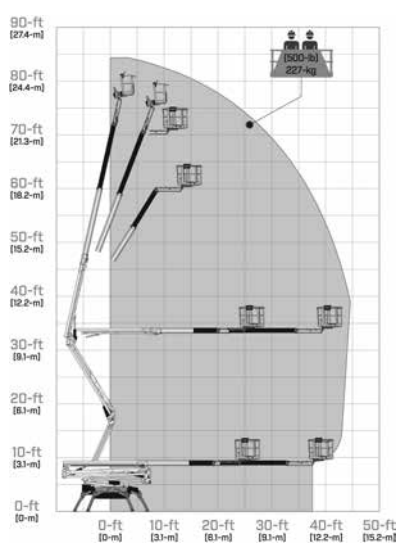

X1000AJ

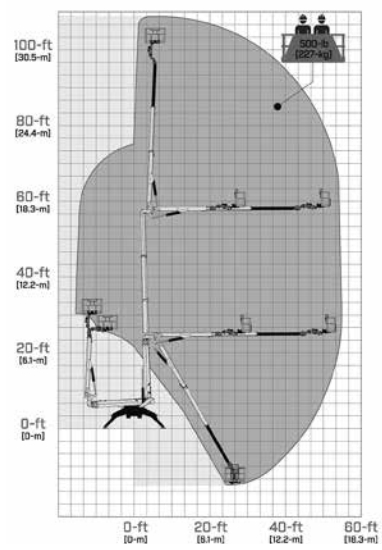

E300AJP

Electric & Hybrid Boom Lifts

E300AJP

Platform Height	29-ft 5-in / 8.96-m
Horizontal Outreach	20-ft 1-in / 6.12-m
Up and Over Height	13-ft 2-in / 4.01-m
Swing	350 Degrees Non-Continuous
Platform Capacity-Unrestricted	500-lb / 227-kg
Platform Capacity-Restricted	N/A
Platform Rotator	180 Degrees Hydraulic
Jib Length (Range of Articulation)	144 Degrees (+84, -60) Vertical
JibPLUS*	180 Degrees Horizontal
Platform Size	30 x 48-in / 0.76 x 1.22-m
Overall Width	4-ft / 1.22-m
Overall Width—Axles Extended	N/A
Tailswing	Zero
Stowed Height	6-ft 7-in / 2.01-m
Stowed Length	18-ft 10-in / 5.74-m
Stowed Length (Drive)	N/A
Wheelbase	5-ft 5-in / 1.65-m
Ground Clearance	4-in / 10-cm
Weight*	15,400-lb / 6,985-kg
Max. Ground Bearing Pressure**	170 psi / 11.95-kg/cm ²
Drive Motors	Dual Electric Traction AC
Brakes	Spring Applied Multiple Discs
Drive Speed 2WD/4WD	4.5 mph / 7.2 km/h
Lift/Lower Speed	24/20 seconds
Gradeability 2WD/4WD	25%
Tilt Cut-Out	3 Degrees
Turning Radius (inside) 2WS/4WS	5-ft / 1.52-m
Turning Radius (outside) 2WS/4WS	10-ft 2-in / 3.1-m
Max Wind Speed Rating	28 mph / 12.5 m/s
Axle Oscillation	N/A
Tire Size/Type	25 x 7 x 12-in Non-Marking
Electrical System	48V DC
Hydraulic Motor/Pump	Perm. Magnet Motor/Gear Pump
Hydraulic Reservoir	2.1 gal / 7.95 L
Fuel Tank Capacity	N/A
Diesel Engine	N/A
Dual Fuel Engine	N/A
Batteries	8 x 6V, 305 amp-hr
Battery Charger	85-265VAC 45/60HZ

*Certain options or country standards increase weight.

**Ground bearing pressure applies to standard tires.

Specifications may change to meet country standards or with addition of optional equipment.

E300AJP

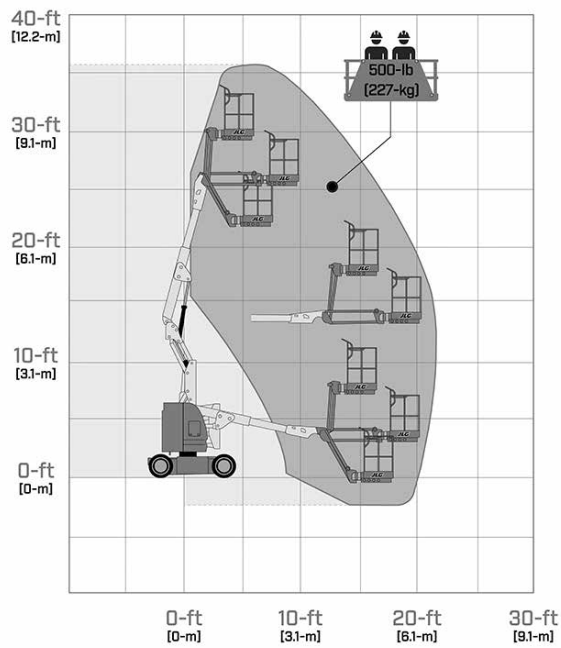

SPECIAL FEATURES INCLUDE:

- 4-ft (1.22-m) articulating jib with JibPLUS®
- ATC (Automatic Traction Control) improves performance on uneven surfaces.
- Ultra compact width of only 4-ft (1.22-m).
- Minimum up and down cycle time of only 105 seconds.
- Brushless AC motors.
- SkyGuard SkyLine™
- Load sensing system

E400AJP NARROW

Electric & Hybrid Boom Lifts

	E400A Narrow	E400AJP Narrow
Platform Height	40-ft / 12.19-m	40-ft / 12.19-m
Horizontal Outreach	21-ft 2-in / 6.45-m	22-ft 5-in / 6.83-m
Up and Over Height	21-ft 6-in / 6.55-m	21-ft 6-in / 6.55-m
Swing	360 Degrees Non-Continuous	360 Degrees Non-Continuous
Platform Capacity-Unrestricted	500-lb / 227-kg	500-lb / 227-kg
Platform Capacity-Restricted	N/A	-
Platform Rotator	180 Degrees Hydraulic	180 Degrees Hydraulic
Jib Length (Range of Articulation)	N/A	144 Degrees (+84, -60) Vertical
JibPLUS*	N/A	180 Degrees Horizontal
Platform Size	30 x 48-in / 0.76 x 1.22-m	30 x 48-in / 0.76 x 1.22-m
Overall Width	4-ft 11-in / 1.5-m	4-ft 11-in / 1.5-m
Overall Width—Axles Extended	N/A	N/A
Tailswing	4-in / 10-cm	4-in / 10-cm
Stowed Height	6-ft 5.75-in / 1.97-m	6-ft 5.75-in / 1.97-m
Stowed Length	18-ft 1-in / 5.51-m	22-ft / 6.71-m
Stowed Length (Drive)	N/A	N/A
Wheelbase	6-ft 7-in / 2.01-m	6-ft 7-in / 2.01-m
Ground Clearance	8.5-in / 22-cm	5-in / 13-cm
Weight*	12,610-lb / 5,720-kg	14,900-lb / 6,759-kg
Max. Ground Bearing Pressure**	95 psi / 6.7-kg/cm ²	185 psi / 13.0-kg/cm ²
Drive Motors	Dual Electric Traction AC	Dual Electric Traction AC
Brakes	Spring Applied Multiple Discs	Spring Applied Multiple Discs
Drive Speed 2WD/4WD	4.2 mph / 6.7 km/h	4.2 mph / 6.7 km/h
Lift/Lower Speed	24/23 seconds	24/23 seconds
Gradeability 2WD/4WD	30%	30%
Tilt Cut-Out	3 Degrees	3 Degrees
Turning Radius (Inside) 2WS/4WS	2-ft 10-in / 86-cm	2-ft 10-in / 86-cm
Turning Radius (Outside) 2WS/4WS	10-ft 4-in / 3.15-m	10-ft 4-in / 3.15-m
Max Wind Speed Rating	28 mph / 12.5 m/s	28 mph / 12.5 m/s
Axle Oscillation	N/A	N/A
Tire Size/Type - Front	22 x 6 x 17.5-in Solid Non-Marking	22 x 6 x 17.5-in Solid Non-Marking
Tire Size/Type - Rear	25 x 7 x 12-in Solid Non-Marking	25 x 7 x 12-in Solid Non-Marking
Electrical System	48V DC	48V DC
Hydraulic Motor/Pump	Perm. Magnet/Gear Pump	Perm. Magnet/Gear Pump
Hydraulic Reservoir	4 gal / 15.14 L	4 gal / 15.14 L
Fuel Tank Capacity	N/A	N/A
Diesel Engine	N/A	N/A
Dual Fuel Engine	N/A	N/A
Batteries	8 x 6V, 312 amp-hr	8 x 6V, 312 amp-hr
Battery Charger	85-265VAC 45/60HZ	85-265VAC 45/60HZ

*Certain options or country standards increase weight.

**Ground bearing pressure applies to standard tires.

Specifications may change to meet country standards or with addition of optional equipment.

E400A NARROW

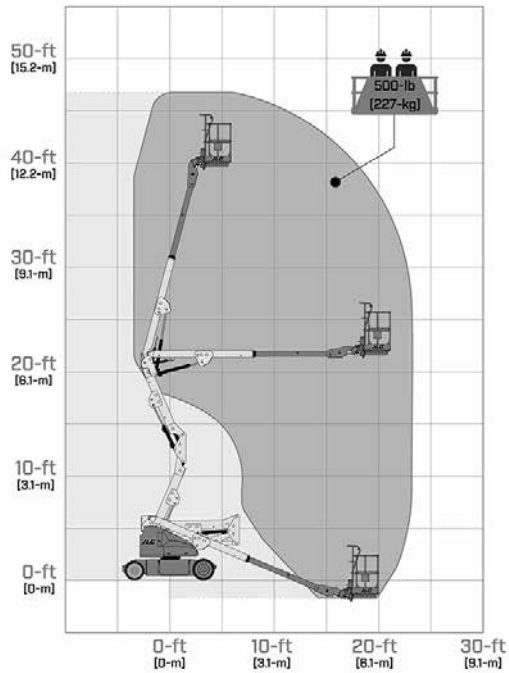

E400AJP NARROW

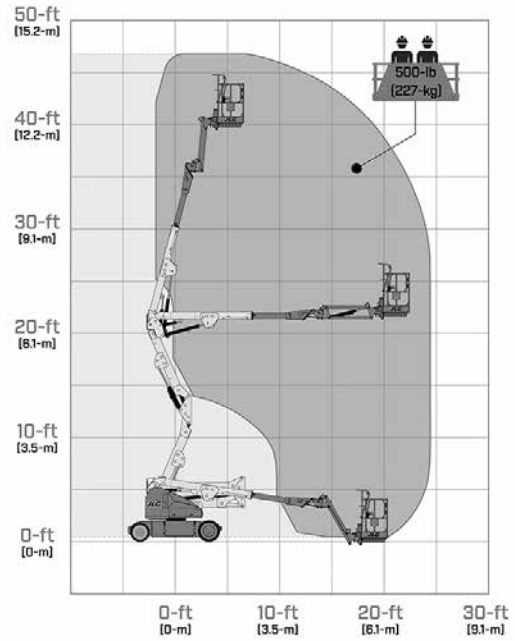

SPECIAL FEATURES INCLUDE:

- JibPLUS[®] provide access in and around confined work areas.
- 4-ft TI-in (1.5-m) narrow chassis for maneuvering in narrow aisles and confined areas.
- ATC (Automatic Traction Control) improves performance on uneven surfaces.
- Brushless AC motors.
- SkyGuard SkyLine™
- Load sensing system



E450 SERIES

Electric Boom Lift

E450AJ

Platform Height	45-ft / 13.72-m
Horizontal Outreach	23-ft 9-in / 7.24-m
Up and Over Height	25-ft 3-in / 7.7-m
Swing	360 Degrees Non-Continuous
Platform Capacity-Unrestricted	500-lb / 227-kg
Platform Capacity-Restricted	N/A
Platform Rotator	180 Degrees Hydraulic
Jib Length (Range of Articulation)	141 Degrees (+86, -55) Vertical
JibPLUS*	N/A
Platform Size	30 x 60-in / 0.76 x 1.52-m
Overall Width	5-ft 9-in / 1.75-m
Overall Width—Axles Extended	N/A
Tailswing	Zero
Stowed Height	6-ft 7-in / 2.01-m
Stowed Length	21-ft 2-in / 6.45-m
Stowed Length (Drive)	N/A
Wheelbase	6-ft 7-in / 2.01-m
Ground Clearance	8-in / 20-cm
Weight*	14,400-lb / 6,532-kg
Max. Ground Bearing Pressure**	110 psi / 7.6-kg/cm ²
Drive Motors	Dual Electric Traction AC
Brakes	Spring Applied Multiple Discs
Drive Speed 2WD/4WD	4.5 mph / 7.2 km/h
Lift/Lower Speed	24/23 seconds
Gradeability 2WD/4WD	30%
Tilt Cut-Out	3 Degrees
Turning Radius (Inside) 2WS/4WS	2-ft / 61-cm
Turning Radius (Outside) 2WS/4WS	10-ft 4-in / 3.15-m
Max Wind Speed Rating	28 mph / 12.5 m/s
Axle Oscillation	N/A
Tire Size/Type	240/55 x 17.5 Foam-Filled
Electrical System	48V DC
Hydraulic Motor/Pump	Perm. Magnet Motor/Gear Pump
Hydraulic Reservoir	4 gal 15.14 L
Fuel Tank Capacity	N/A
Diesel Engine	N/A
Dual Fuel Engine	N/A
Batteries	8 x 6V, 375 amp-hr
Battery Charger	85-265VAC 45/60HZ

*Certain options or country standards increase weight.

**Ground bearing pressure applies to standard tires.

Specifications may change to meet country standards or with addition of optional equipment.

E450AJ

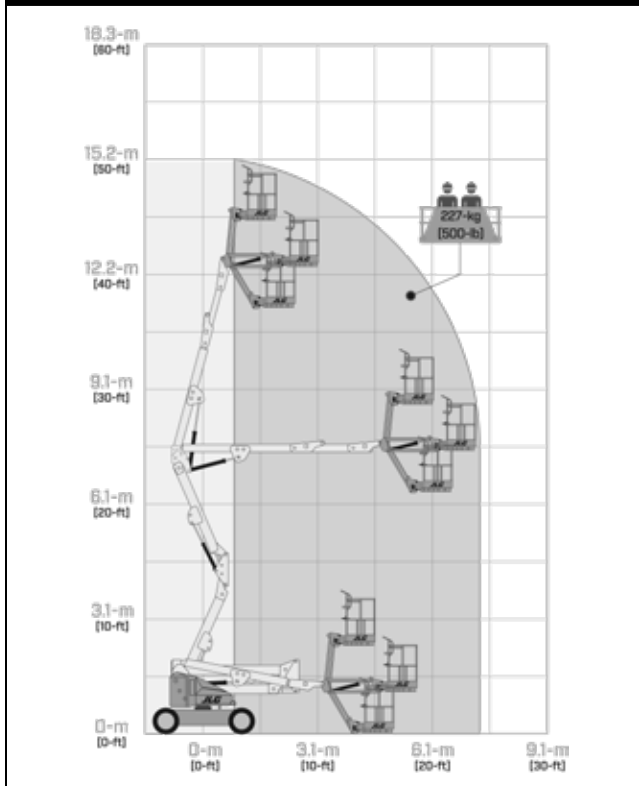

SPECIAL FEATURES INCLUDE:

- ATC (Automatic Traction Control) improves performance on uneven surfaces.
- Jib provides up and over access in confined work areas.
- Brushless AC motors.
- SkyGuard SkyLine™
- Load sensing system

EC600 & H600 SERIES

Electric & Hybrid Boom Lifts

	EC600SJ/H600SJ	EC600SJP/H600SJP
Platform Height	60-ft 3-in / 18.36-m	60-ft 4-in / 18.39-m
Horizontal Outreach	43-ft 3-in / 13.18-m	44-ft 5-in / 13.54-m
Up and Over Height	*Applicable to Articulating ONLY*	*Applicable to Articulating ONLY*
Swing	400 Degrees Non-Continuous	400 Degrees Non-Continuous
Platform Capacity-Unrestricted	500-lb / 227-kg	500-lb / 227-kg
Platform Capacity-Restricted	N/A	N/A
Platform Rotator	180 Degrees Hydraulic	180 Degrees Hydraulic
Jib Length (Range of Articulation)	145 Degrees (+75, -70) Vertical	145 Degrees (+89, -56) Vertical
JibPLUS*	N/A	180 Degrees Horizontal
Platform Size	30 x 72-in / 0.76 x 1.83-m	30 x 72-in / 0.76 x 1.83-m
Overall Width	7-ft 11-in / 2.41-m	7-ft 11-in / 2.41-m
Overall Width—Axles Extended	N/A	N/A
Tailswing	4-ft / 1.22-m	4-ft / 1.22-m
Stowed Height	8-ft 4-in / 2.54-m	8-ft 4-in / 2.54-m
Stowed Length	30-ft 9-in / 9.37-m	33-ft 4-in / 10.16-m
Stowed Length (Drive)	N/A	N/A
Wheelbase	9-ft / 2.74-m	9-ft / 2.74-m
Ground Clearance	10-in / 26-cm	14-in / 36-cm
Weight*	16,710-lb / 7,580-kg	17,210-lb / 7,807-kg
Max. Ground Bearing Pressure**	52 psi / 3.7-kg/cm ²	51 psi / 3.6-kg/cm ²
Drive Motors	Dual Electric Traction	Dual Electric Traction
Brakes	Spring Applied Multiple Discs	Spring Applied Multiple Discs
Drive Speed 2WD/4WD	3.0 mph / 4.8 km/h	3.0 mph / 4.8 km/h
Lift/Lower Speed	55/55 seconds	55/55 seconds
Gradeability 2WD/4WD	30%/45%	30%/45%
Tilt Cut-Out	4 Degrees	4 Degrees
Turning Radius (Inside) 2WS/4WS	4-ft / 1.22-m	4-ft / 1.22-m
Turning Radius (Outside) 2WS/4WS	15-ft 2.5-in / 4.64-m	15-ft 2.5-in / 4.64-m
Max Wind Speed Rating	28 mph / 12.5 m/s	28 mph / 12.5 m/s
Axle Oscillation	8-in / 20-cm	8-in / 20-cm
Tire Size/Type	36 x 14-22.5-in Non-Marking Foam-Filled	36 x 14-22.5-in Non-Marking Foam-Filled
Electrical System	48V DC	48V DC
Hydraulic Motor/Pump	Series Wound Motor/Gear Pump	Series Wound Motor/Gear Pump
Hydraulic Reservoir	15 gal / 56.78 L	15 gal / 56.78 L
Fuel Tank Capacity	13 gal / 49.21 L	13 gal / 49.21 L
Diesel Engine	45 Amp Kubota 6.7 hp Diesel Engine	45 Amp Kubota 6.7 hp Diesel Engine
Dual Fuel Engine	N/A	N/A
Batteries	8 x 6V, 415 amp-hr	8 x 6V, 415 amp-hr
Battery Charger	110V 60HZ	110V 60HZ

*Certain options or country standards increase weight.

**Ground bearing pressure applies to standard tires.

Specifications may change to meet country standards or with addition of optional equipment.

EC/H600SJ

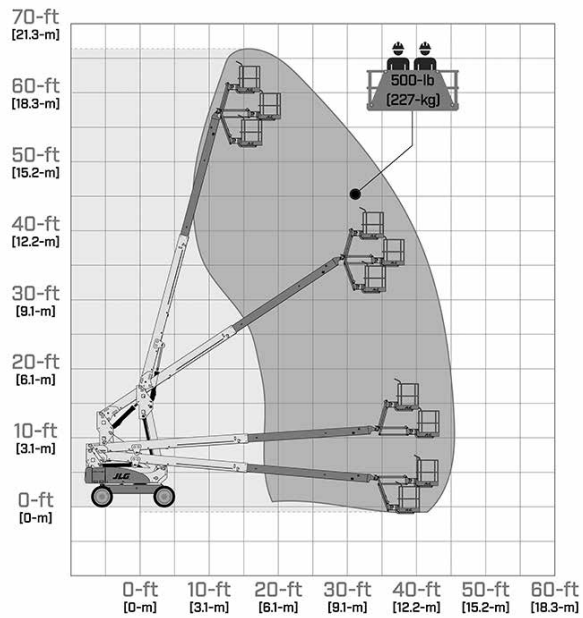

EC/H600SJP

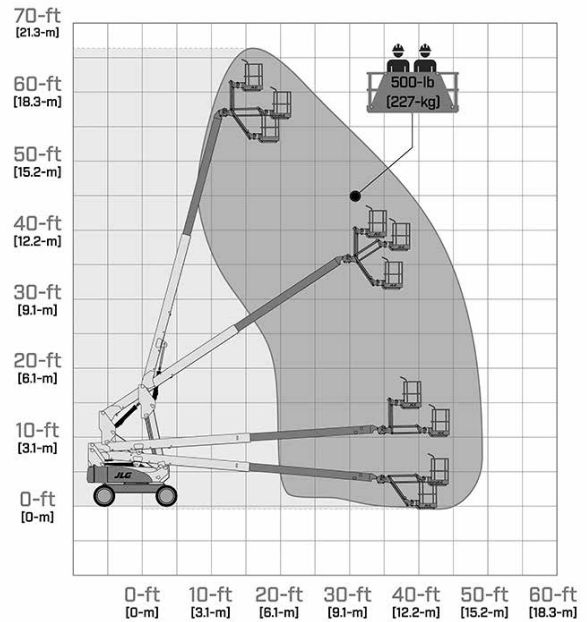

SPECIAL FEATURES INCLUDE:

- The world's first 60-foot Electric Boom — indoor and outdoor versatility.
- Indoor advantages — Zero emissions, industry-leading noise reduction, non-marking tires and the lowest weight in its class.
- Outdoor advantages — Rugged design with available all-wheel drive, automatic traction control and oscillating axle.
- SkyGuard SkyLine™
- Load sensing system

H340AJ

Electric & Hybrid Boom Lifts

H340AJ

Platform Height	33-ft 10.5-in / 10.33-m
Horizontal Outreach	19-ft 11-in / 6.06-m
Up and Over Height	17-ft / 5.17-m
Swing	355 Degrees Non-Continuous
Platform Capacity-Unrestricted	500-lb / 227-kg
Platform Capacity-Restricted	N/A
Platform Rotator	180 Degrees Hydraulic
Jib Length (Range of Articulation)	4-ft / 1.22-m -139 Degrees (+79, -60)
JibPLUS*	N/A
Platform Size	30 x 60-in / 0.76 x 1.22-m
Overall Width	6-ft 4-in / 1.93-m
Overall Width—Axles Extended	N/A
Tailswing	2-in / 5.08-cm
Stowed Height	6-ft 7-in / 2-m
Stowed Length	18-ft 2-in / 5.52-m, 13-ft 1-in / 3.98-m with Jib Stowed
Stowed Length (Drive)	N/A
Wheelbase	6-ft 2-in / 1.87-m
Ground Clearance	10-in / 26-cm
Weight*	9,860-lb / 4,472-kg
Max. Ground Bearing Pressure**	64 psi / 4.5-kg/cm ²
Drive Motors	Dual Electric Traction
Brakes	N/A
Drive Speed 2WD/4WD	3.7 mph / 5.95 km/h
Lift/Lower Speed	19/16 seconds
Gradeability 2WD/4WD	45%
Tilt Cut-Out	4 Degrees
Turning Radius (Inside) 2WS/4WS	5-ft / 1.52-m
Turning Radius (Outside) 2WS/4WS	13-ft / 3.96-m
Max Wind Speed Rating	28 mph / 12.5 m/s
Axle Oscillation	4.5-in / 12-cm
Tire Size/Type	265/50 D20 Foam-Filled Lug Tread
Electrical System	48V DC
Hydraulic Motor/Pump	Tandem Gear Pump Set
Hydraulic Reservoir	20.6 gal / 77.9 L
Fuel Tank Capacity	13 gal / 49.2 L
Diesel Engine	Kubota Z482 11.1 hp / 8.3 kW
Dual Fuel Engine	N/A
Batteries	8 x 12V 100 amp-hr AGM
Battery Charger	85-265VAC 45/60HZ

*Certain options or country standards increase weight.

**Ground bearing pressure applies to standard tires.

Standard with glow plugs.

Specifications may change to meet country standards or with addition of optional equipment.

H340AJ

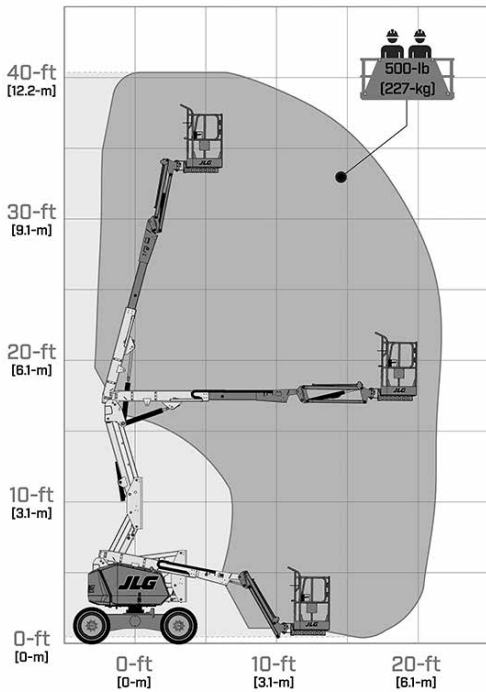

SPECIAL FEATURES INCLUDE:

- Indoor and outdoor use—
Less noise and lower emissions give access to job sites where traditional diesel machines are not allowed to operate.
- Power and performance—
Four individually controlled drive motors provide four-wheel drive and exceptional terrainability on par with its diesel counterpart.
- Reduced maintenance—
Direct AC electric drive reduces the number of hydraulic hoses and fittings as well as the potential for leaks by 40% over hydraulic-powered counterparts.
- SkyGuard SkyLine™
- Load sensing system

340AJ & 450 SERIES

Articulating Boom Lifts

	340AJ	450AJ	450AJ HC3
Platform Height	33-ft 10.5-in / 10.33-m	45-ft / 13.72-m	45-ft / 13.72-m
Horizontal Outreach	19-ft 11-in / 6.06-m	25-ft / 7.62-m	25-ft / 7.62-m
Up and Over Height	17-ft / 5.17-m	24-ft / 7.3-m	24-ft / 7.3-m
Swing	355 Degrees Non-Continuous	355 Degrees Non-Continuous	355 Degrees Non-Continuous
Platform Capacity-Unrestricted	500-lb / 227-kg	550-lb / 250-kg	660-lb / 300-kg
Platform Capacity-Restricted	500-lb / 227-kg	550-lb / 250-kg	750/1,000-lb / 340/454-kg
Platform Rotator	180 Degrees Hydraulic	180 Degrees Hydraulic	180 Degrees Hydraulic
Jib Length (Range of Articulation)	4-ft / 1.22-m / 139 Degrees (+79,-60)	4-ft 1-in / 1.24-m / 145 Degrees (+76,-69)	4-ft 1-in / 1.24-m / 145 Degrees (+76,-69)
JibPLUS*	-	-	-
Platform Size	30 x 60-in / 0.76 x 1.52-m	30 x 72-in / 0.76 x 1.83-m	30 x 72-in / 0.76 x 1.83-m
Overall Width	6-ft 4-in / 1.93-m	7-ft 8.6-in / 2.35-m	7-ft 8.6-in / 2.35-m
Overall Width—Axles Extended	N/A	N/A	N/A
Tailswing	2-in / 5.08-cm	Zero	Zero
Stowed Height	6-ft 7-in / 2-m	7-ft 5.3-in / 2.27-m	7-ft 5.3-in / 2.27-m
Stowed Length	18-ft 2-in / 5.52-m / 13-ft 2-in / 4.02-m with Jib Stowed	21-ft 6.9-in / 6.57-m	21-ft 6.9-in / 6.57-m
Stowed Length (Drive)	N/A	N/A	N/A
Wheelbase	6-ft 2-in / 1.87-cm	7-ft 9-in / 2.36-m	7-ft 9-in / 2.36-m
Ground Clearance	10-in / 23.7-cm	16.4-in / 41.7-cm	16.4-in / 41.7-cm
Weight*	10,175-lbs / 4,615-kg	14,150-lb / 6,418-kg	16,550-lb / 7,507-kg
Max. Ground Bearing Pressure**	62 psi / 4.3 kg/cm ²	65 psi / 4.57-kg/cm ²	76 psi / 5.34-kg/cm ²
Drive Speed 2WD/4WD	3.1 mph / 4.98 km/h- 2WD Only	4.25 mph / 6.84 km/h	4.25 mph / 6.84 km/h
Lift/Lower Speed	19/13 seconds	23/23 seconds	23/23 seconds
Gradeability 2WD/4WD	45%	45% / 2WD-30%	45%
Tilt Cut-Out	4 Degrees	5 Degrees	5 Degrees
Turning Radius (Inside) 2WS/4WS	5-ft / 1.52-m	6-ft 9-in / 2.06-m	6-ft 9-in / 2.06-m
Turning Radius (Outside)	13-ft / 3.96-m	15-ft 8-in / 4.78-m	15-ft 8-in / 4.78-m
Max Wind Speed Rating	28 mph / 12.5 m/s	28 mph / 12.5 m/s	28 mph / 12.5 m/s
Axle Oscillation	4.5-in / 12-cm	4-in / 10-cm	4-in / 10-cm
Tire Size/Type	265/50 D20 Foam-Filled Lug Tread	33/1550 x 16.5 Foam-Filled Lug Tread	33 x 12 D610 Foam-Filled
Electrical System	12V DC	12V DC	12V DC
Hydraulic Reservoir	20.6 gal / 77.9 L	36 gal / 136.3 L	17.3 gal / 65.5 L
Fuel Tank Capacity	13 gal / 49.21 L	16 gal / 60.6 L	16 gal / 60.6 L
Diesel Engine	Kubota D1105 24.8 hp / 18.5 kW	Deutz D2.9L4 Tier 4 Final 49 hp / 36.4 kW	Deutz D2.9L4 Tier 4 Final 49 hp / 36.4 kW
Dual Fuel Engine	PSI/GM L4 EFI 28.7 hp / 21.4 kW	Kubota WG2503 60hp / 44kW	Kubota WG2503 60hp / 44kW

*Certain options or country standards increase weight.

**Ground bearing pressure applies to standard tires.

Standard with glow plugs.

Specifications may change to meet country standards or with addition of optional equipment.

340AJ

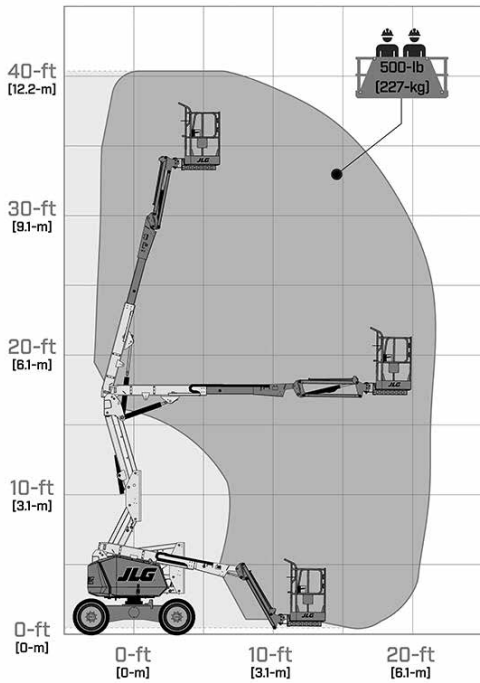

SPECIAL FEATURES INCLUDE:

- Lighter weight 340AJ provides for more efficient performance over a wide range of applications and reduced transport costs.
- Increased work envelope with optimum up and over clearance and horizontal outreach.
- Improved rough terrain capabilities with standard 4-wheel drive (45-ft models), oscillating axle and 45% gradeability.
- Enhanced electrical and hydraulic systems minimize wiring and hoses, reducing wear and maintenance.
- SkyGuard SkyLine™
- Load sensing system

3 Capacity Zones - Each rated for up to 3 occupants + tools/materials

HC3

450AJ

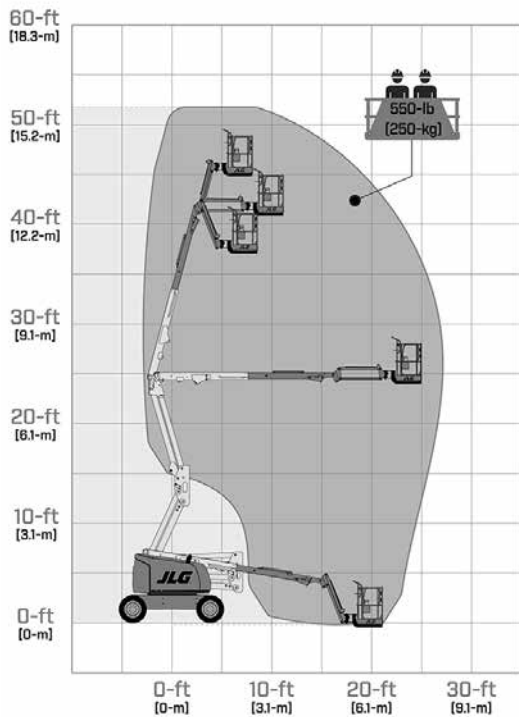

450AJ HC3

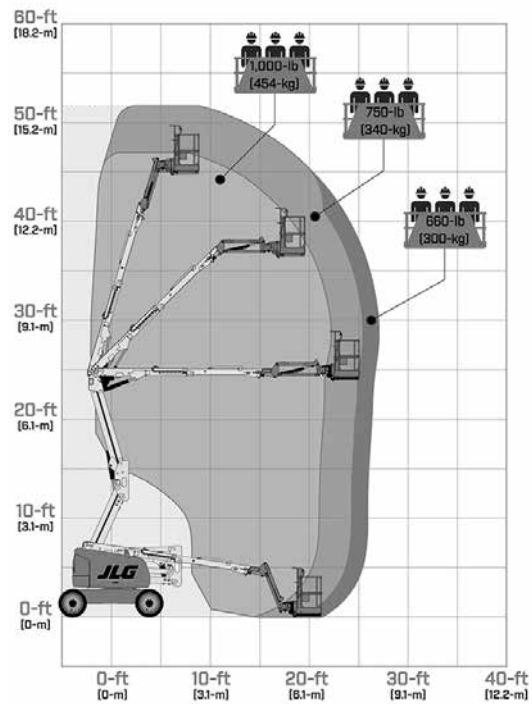

600 SERIES

Articulating Boom Lifts

	600AJ	600AJ Narrow	600AJ HC3
Platform Height	60-ft 7-in / 18.47-m	60-ft 7-in / 18.47-m	60-ft / 18.3-m
Horizontal Outreach	39-ft 9-in / 12.1-m	39-ft 9-in / 12.1-m	40-ft 6.9-in / 12.37-m
Up and Over Height	26-ft 7-in / 8.1-m	26-ft 7-in / 8.1-m	26-ft 6.4-in / 8.1-m
Swing	360 Degrees Continuous	360 Degrees Continuous	360 Degrees Continuous
Platform Capacity-Unrestricted	500-lb / 227-kg	500-lb / 227-kg	660-lb / 300-kg
Platform Capacity-Restricted	500-lb / 227-kg	500-lb / 227-kg	750/1000-lb / 340/454-kg
Platform Rotator	180 Degrees Hydraulic	180 Degrees Hydraulic	180 Degrees Hydraulic
Jib Length (Range of Articulation)	130 Degrees (+70,-60)	130 Degrees (+70,-60)	130 Degrees (+70,-60)
JibPLUS*	-	-	-
Platform Size	36 x 96-in / 0.91 x 2.44-m	36 x 96-in / 0.91 x 2.44-m	36 x 96-in / 0.91 x 2.44-m
Overall Width	8-ft 2-in / 2.48-m	7-ft / 2.14-m	8-ft 2.2-in / 2.49-m
Overall Width—Axles Extended	N/A	N/A	N/A
Tailswing	Zero	5-ft 6-in / 1.6-m	Zero
Stowed Height	8-ft 4-in / 2.54-m	8-ft 4-in / 2.54-m	8-ft 5.5-in / 2.58-m
Stowed Length	28-ft 11.5-in / 8.83-m	28-ft 11.5-in / 8.83-m	30-ft / 9.14-m
Stowed Length (Drive)	N/A	N/A	N/A
Wheelbase	8-ft / 2.44-m	8-ft / 2.44-m	8-ft 1.9-in / 2.48-m
Ground Clearance	12-in / 30-cm	12-in / 30-cm	11.8-in / 29-cm
Weight*	22,691-lb / 10,292-kg	24,200-lb / 10,977-kg	26,057-lb / 11,819-kg
Max. Ground Bearing Pressure**	75 psi / 5.5-kg/cm ²	90 psi / 6.2-kg/cm ²	90 psi / 6.2-kg/cm ²
Drive Speed 2WD/4WD	4.25 mph / 6.8 km/h	4.25 mph / 6.8 km/h	4.01 mph / 6.45 km/h-4WD
Lift/Lower Speed	26/26 seconds	26/26 seconds	26/26 seconds
Gradeability 2WD/4WD	30%/45%	30%/45%	30%/45%
Tilt Cut-Out	4 Degrees	3 Degrees	5 Degrees
Turning Radius (inside) 2WS/AWS	10-ft 11-in / 3.33-m / 4-ft 7-in / 1.41-m	5-ft 7-in / 1.7-m-2WS	7-ft 1-in / 2.15-m-2WS
Turning Radius (outside)	17-ft 8-in / 5.38-m / 9-ft 7-in / 2.92-m	11-ft 2-in / 3.4-m-2WS	16-ft 11.3-in / 5.17-m-2WS
Max Wind Speed Rating	28 mph / 12.5 m/s	28 mph / 12.5 m/s	28 mph / 12.5 m/s
Axle Oscillation	8-in / 20-cm	8-in / 20-cm	7.2-in / 18.3-cm
Tire Size/Type	IN355/55D-6.25 Low Profile/Foam-Filled	IN355/55D-6.25 Low Profile/Foam-Filled	IN355/55D-6.25 Low Profile/Foam-Filled
Electrical System	12V DC	12V DC	12V DC
Hydraulic Reservoir	30.6 gal / 115.83 L	30.6 gal / 115.83 L	30.6 gal / 115.83 L
Fuel Tank Capacity	30 gal / 113.56 L	30 gal / 113.56 L	30 gal / 113.56 L
Diesel Engine	Deutz TD 2.9L T4F 48.8 hp / 36.4 kW	Deutz TD 2.9L T4F 48.8 hp / 36.4 kW	Deutz TD 2.9L T4F 48.8 hp / 36.4 kW
Dual Fuel Engine	Ford DF 2.5L 84 hp / 62 kW	Ford DF 2.5L 84 hp / 62 kW	Ford DF 2.5L 84 hp / 62 kW

*Certain options or country standards increase weight.

**Ground bearing pressure apply to standard tires.

Specifications may change to meet country standards or with addition of optional equipment.

600AJ

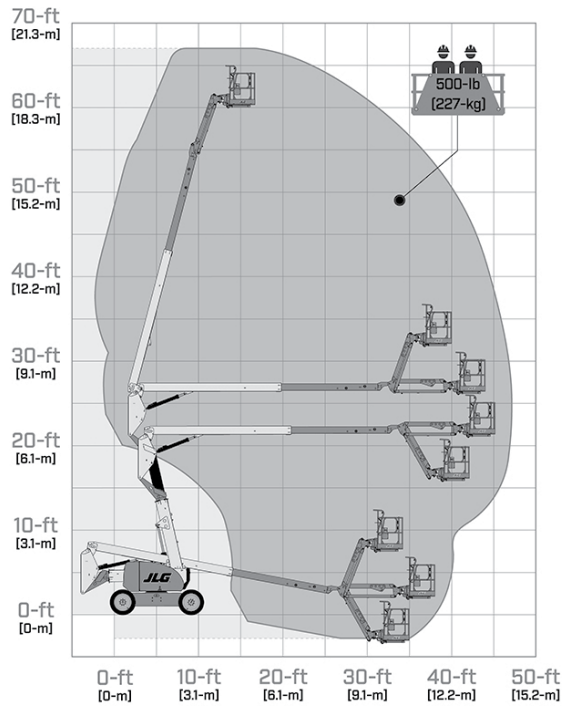

600AJ HC3

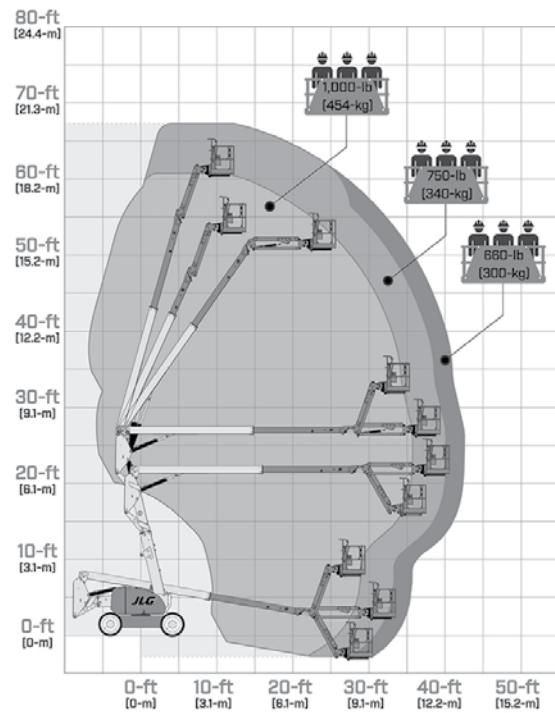

SPECIAL FEATURES INCLUDE:

- Platform controls with one-hand control of lift and swing.
- Advanced boom design provides optimal reach envelope with zero tailswing.
- Swing-out engine tray for ease of access.
- Oscillating axle and 4-wheel drive for superior traction.
- Revolutionary WorkStation in the Sky® options and accessories.
- SkyGuard SkyLine™
- Load sensing system

HC3

3 Capacity Zones - Each rated for up to 3 occupants + tools/materials



800AJ

Articulating Boom Lifts

	800AJ	800AJ HC3
Platform Height	80-ft / 24.38-m	80-ft 4.4-in / 24.5-m
Horizontal Outreach	51-ft 10-in / 15.8-m	52-ft 3.8-in / 15.9-m
Up and Over Height	32-ft 1-in / 9.78-m	32-ft 5.1in / 9.9-m
Swing	360 Degrees Continuous	360 Degrees Continuous
Platform Capacity-Unrestricted	500-lb / 227-kg	660-lb / 300-kg
Platform Capacity-Restricted	N/A	750 / 1000-lb / 340 / 454-kg
Platform Rotator	180 Degrees Hydraulic	180 Degrees Hydraulic
Jib Length (Range of Articulation)	6-ft / 1.83-m / 130 Degrees (+70,-60)	6-ft / 1.83-m / 130 Degrees (+70,-60)
JibPLUS*	-	-
Platform Size	36 x 72-in / 0.91 x 1.82-m	36 x 72-in / 0.91 x 1.82-m
Overall Width	8-ft 2-in / 2.48-m	8-ft 1.5-in / 2.48-m
Overall Width—Axles Extended	N/A	N/A
Tailswing	2-ft 6-in / 76-cm	2-ft 5-in / 74-cm
Stowed Height	9-ft 10-in / 3.0-m	9-ft 9.1-in / 2.97-m
Stowed Length	36-ft 6-in / 11.13-m	36-ft 9.9-in / 11.22-m
Stowed Length (Drive)	N/A	N/A
Wheelbase	10-ft / 3.05-m	10-ft / 3.05-m
Ground Clearance	11-in / 28-cm	11-in / 28-cm)
Weight*	34,738-lb / 15,757-kg	37,530-lb / 17,023-kg
Max. Ground Bearing Pressure**	76 psi / 5.3-kg/cm2	76 psi / 5.3-kg/cm2
Drive Speed 2WD/4WD	3.6 mph / 5.8 kmh	3.6 mph / 5.8 kmh
Lift/Lower Speed	45/45 seconds	45/45 seconds
Gradeability 2WD/4WD	30%/45%	30%/45%
Tilt Cut-Out	4 Degrees	4 Degrees
Turning Radius (Inside) 2WS/4WS	12-ft 6-in / 3.8-m / 6-ft / 1.83-m	10-ft 2.9-in / 3.12-m
Turning Radius (Outside)	19-ft 8-in / 6.02-m / 11-ft 7-in / 3.53-m	21-ft 6.2-in / 6.56-m
Max Wind Speed Rating	28 mph / 12.5 m/s	28 mph / 12.5 m/s
Axle Oscillation	8-in / 20-cm	8-in / 20-cm
Tire Size/Type	18-625 Foam-Filled	18-625 Foam-Filled
Electrical System	12V DC	12V DC
Hydraulic Reservoir	40 gal / 151.42 L	40 gal / 151.42 L
Fuel Tank Capacity	39 gal / 147.63 L	39 gal / 147.63 L
Diesel Engine	Deutz TD2.9L4 Tier 4 Final 67 hp / 50 kW	Deutz TD2.9L4 Tier 4 Final 67 hp / 50 kW
Dual Fuel Engine	Ford MSG425-DF 84 hp / 62.6 kW	Ford MSG425-DF 84 hp / 62.6 kW

*Certain options or country standards increase weight.

**Ground bearing pressure applies to standard tires.

Specifications may change to meet country standards or with addition of optional equipment.

800AJ

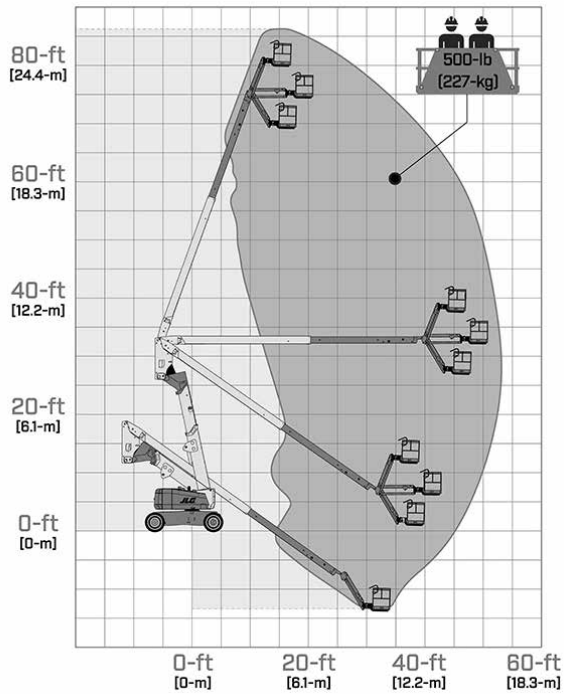

800AJ HC3

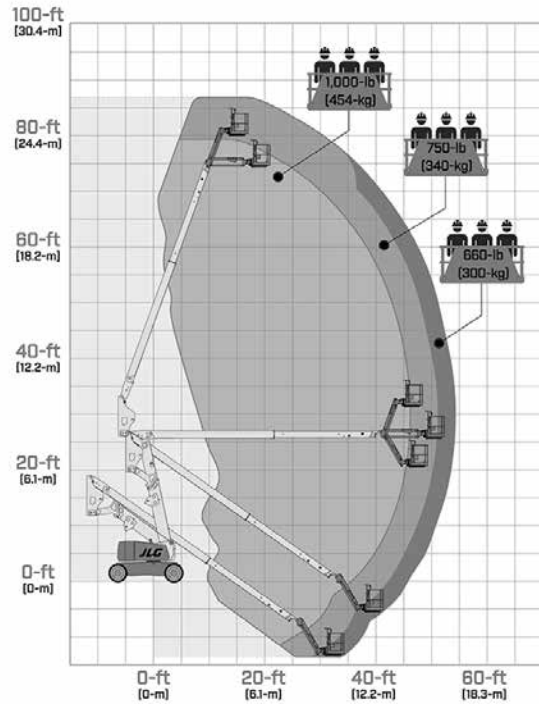

SPECIAL FEATURES INCLUDE:

- Exclusive QuikStik® boom — 50 seconds from ground to full elevation.
- Optional oscillating axle and 4-wheel drive for superior traction.
- Narrow 8-ft 2-in (2.48-m) chassis for improved access.
- WorkStation in the Sky® options and accessories.
- SkyGuard SkyLine™
- Load sensing system

HC3

3 Capacity Zones - Each rated for up to 3 occupants + tools/materials

ULTRA SERIES

Articulating Boom Lifts

	1250AJP	1500AJP
Platform Height	125-ft 8-in / 38.3-m	150-ft / 45.72-m
Horizontal Outreach	63-ft 2-in / 19.25-m	75-ft / 22.86-m
Up and Over Height	60-ft 6-in / 18.44-m	60-ft 4-in / 18.4-m
Swing	360 Degrees Continuous	360 Degrees Continuous
Platform Capacity-Unrestricted	500-lb / 227-kg	600-lb / 272-kg
Platform Capacity-Restricted ¹	1,000-lb / 454-kg	1,000-lb / 454-kg
Platform Rotator	180 Degrees Hydraulic	180 Degrees Hydraulic
Jib Length (Range of Articulation)	8-ft / 2.44-m / 130 Degrees (+75,-55)	8-ft / 2.4-m / 131 Degrees (+75,-55)
JibPLUS [*]	125 Degrees Hydraulic	180 Degrees Hydraulic
Platform Size	36-in x 96-in / 0.91 x 2.44-m	36 x 96-in / .91 x 2.44-m
Overall Width	8-ft 2-in / 2.49-m	8-ft 1.5-in / 2.5-m
Overall Width—Axles Extended	12-ft 6-in / 3.81-m	16-ft 6-in / 5-m
Tailswing	9-ft 3-in / 2.84-m	2-ft 5-in / 0.7-m
Stowed Height	9-ft 11-in / 3.02-m	10-ft 2-in / 3.1-m
Stowed Length	37-ft 7-in / 11.45-m	39-ft 8-in / 12.09-m
Stowed Length (Drive)	47-ft 6-in / 14.48-m	49-ft 8-in / 15.1-m
Wheelbase	12-ft 6-in / 3.81-m	15-ft / 4.6-m extended 17-ft 1.50-in / 5.22-m retracted
Ground Clearance		
— Axle	12-in / 30-cm	15-in / 38-cm
— Chassis	25.5-in / 65-cm	15.75-in / 40-cm
Weight [*]	44,000-lb / 19,958-kg	57,380-lb / 26,027-kg
Max. Ground Bearing Pressure ^{**}	100 psi / 7.03-kg/cm ²	122.5 psi / 8.4-kg/cm ²
Drive Speed 2WD/4WD	3.25 mph / 5.2 km/h	2.8 mph / 4.5 km/h
Lift/Lower Speed	57/59 seconds	70/70 seconds
Gradeability 2WD/4WD	45%	40%
Tilt Cut-Out	5 Degrees	5 Degrees
Turning Radius (Inside) 2WS/4WS	14-ft 5-in / 4.39-m / Axles Retracted 8-ft / 2.44-m / Axles Extended	23-ft 4-in / 7.11-m / Axles Retracted 7-ft 6-in / 2.28-m / Axles Extended
Turning Radius (Outside)	22-ft 6-in / 6.86-m / Axles Retracted/ 19-ft 4-in / 5.89-m / Axles Extended	31-ft 3-in / 9.52-m / Axles Retracted/ 21-ft 8-in / 6.6-m / Axles Extended
Max Wind Speed Rating	28 mph / 12.5 m/s	28 mph / 12.5 m/s
Axle Oscillation	8-in / 20-cm	N/A
Crab Steer Ratio ²	1:1	1:1
Tire Size/Type	445/50D710 Foam-Filled	445/50D710 Foam-Filled
Electrical System	12V DC	12V DC
Hydraulic Reservoir	53 gal / 200.63 L	93 gal / 352 L
Fuel Tank Capacity	31 gal / 117.35 L	45 gal / 170 L
Diesel Engine	Deutz TCD2.9L4 74.2 hp / 55.4 kW Tier 4 Final	Deutz TCD 3.6L 99.8 hp / 74.45 kW
Dual Fuel Engine	N/A	N/A

^{*}Certain options or country standards increase weight

^{**}Ground bearing pressure applies to standard tires.

1. Capacity is limited to 500-lb when JibPLUS[®] is swung off-center (600-lb on 1500AJP).

2. Ratio of forward travel to lateral travel.

Specifications may change to meet country standards or with addition of optional equipment.

1250AJP

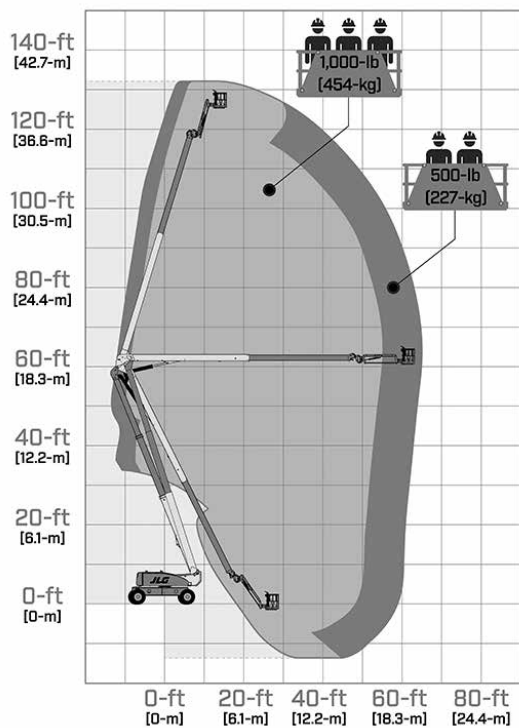

1500AJP

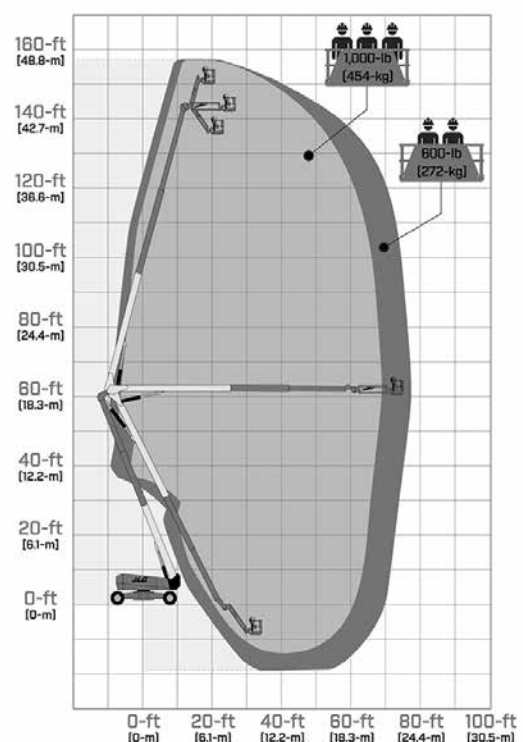

SPECIAL FEATURES INCLUDE:

- Huge Work Envelope — up to 2.6 million cubic foot work envelope means you can access otherwise inaccessible areas.
- Best Mobility in Class — Tightest turning radius, best crab-steer ratio, drive-out extendable axles and the only oscillating axle (1250AJP only) in its class means you can take these big boom lifts where no others can go.
- WorkStation in the Sky® options and accessories.
- Exclusive QuikStik® Boom — 115 seconds from full elevation to ground (180 seconds for the 1500AJP). 100,000 psi steel in the boom helps you get more work done with higher platform capacities and built-in power tools.
- SkyGuard SkyLine™
- Load sensing system

400 SERIES

Telescopic Boom Lifts

	400S	400S HC3	460SJ	460SJ HC3
Platform Height	40-ft / 12.36-m	40-ft / 12.19-m	46-ft / 14.05-m	46-ft / 14.05-m
Horizontal Outreach	33-ft 3-in / 10-m	33-ft 7-in / 10.23-m	39-ft / 12-m	39-ft / 12-m
Up and Over Height	N/A	N/A	N/A	N/A
Swing	360 Degrees Continuous	360 Degrees Continuous	360 Degrees Continuous	360 Degrees Continuous
Platform Capacity-Unrestricted	600-lb / 272-kg	660-lb / 300-kg	600-lb / 272-kg	660-lb / 300-kg
Platform Capacity-Restricted	1,000-lb / 454-kg	750/1,000-lb / 340/454-kg	600-lb / 272-kg	750/1,000-lb / 340/454-kg
Platform Rotator	180 Degrees Hydraulic	180 Degrees Hydraulic	180 Degrees Hydraulic	N/A
Jib Length (Range of Articulation)	130 Degrees (+70,-60)	N/A	6-ft / 1.83-m	6-ft / 1.83-m
JibPLUS*	N/A	N/A	180 Degrees Horizontal	N/A
Platform Size	36 x 96-in / 0.91 x 2.44-m	36 x 96-in / 0.91 x 2.44-m	36 x 96-in / 0.91 x 2.44-m	36 x 96-in / 0.91 x 2.44-m
Overall Width	7-ft 6.8-in / 2.31-m	7-ft 6.8-in / 2.31-m	7-ft 6.8-in / 2.31-m	7-ft 6.8-in / 2.31-m
Overall Width—Axles Extended	N/A	N/A	N/A	N/A
Tailswing	2-ft 10-in / 86-cm	2-ft 10-in / 86-cm	2-ft 10-in / 86-cm	3-ft 0.5-in / 93-cm
Stowed Height	8-ft 1-in / 2.47-m	8-ft 1-in / 2.47-m	8-ft 1-in / 2.47-m	8-ft 1-in / 2.47-m
Stowed Length	24-ft 11-in / 7.6-m	24-ft 11-in / 7.6-m	29-ft 3-in / 8.91-m	29-ft 8.2-in / 9.10-m
Stowed Length (Drive)	N/A	N/A	N/A	N/A
Wheelbase	7-ft 9.5-in / 2.37-m	7-ft 9.5-in / 2.37-m	7-ft 9.5-in / 2.37-m	7-ft 9.5-in / 2.37-m
Ground Clearance	12-in / 30-cm	12-in / 30-cm	12-in / 30-cm	12-in / 30-cm
Weight*	13,640-lb / 6,187-kg	15,040-lb / 6,822-kg	16,600-lb / 7,530-kg	20,516-lb / 9,306-kg
Max. Ground Bearing Pressure**	58 psi / 4.00-kg/cm ²	65 psi / 4.57-kg/cm ²	69 psi / 4.76-kg/cm ²	971 psi / 6.8-kg/cm ²
Drive Speed 2WD/4WD	4.25 mph / 6.8 km/h	4.25 mph / 6.8 km/h	4.25 mph / 6.8 km/h	4.25 mph / 6.8 km/h
Lift/Lower Speed	34/34 seconds	33/33 seconds	34/34 seconds	34/34 seconds
Gradeability 2WD/4WD	45%	45%	45%	45%
Tilt Cut-Out	5 Degrees	5 Degrees	5 Degrees	5 Degrees
Slope Leveling Capacity	N/A	N/A	N/A	N/A
Slope Leveling Capacity	N/A	N/A	N/A	N/A
Turning Radius (Inside) 2WS/4WS	6-ft 5-in / 2.0-m	6-ft 9.4-in / 2.07-m	6-ft 6.9-in / 2.0-m	6-ft 8.7-in / 2.05-m
Turning Radius (Outside) 2WS/4WS	15-ft 8-in / 4.8-m	15-ft 8-in / 4.8-m	15-ft 10.5-in / 4.8-m	15-ft 8.6-in / 4.8-m
Max Wind Speed Rating	28 mph / 12.5 m/s	28 mph / 12.5 m/s	28 mph / 12.5 m/s	28 mph / 12.5 m/s
Axle Oscillation	-	4.4-in / 0.11-m	-	-
Tire Size/Type	12 x 16.5 Foam-Filled Lug Tread	12 x 16.5 Foam-Filled	12 x 16.5 Foam-Filled Lug Tread	33 X 12 Foam-Filled
Electrical System	12V DC	12V DC	12V DC	12V DC
Hydraulic Reservoir	36 gal / 136 L	36 gal / 136 L	36 gal / 136 L	36 gal / 136 L
Fuel Tank Capacity	22 gal / 83.3 L	22 gal / 83.3 L	22 gal / 83.3 L	22 gal / 83.3 L
Diesel Engine	Deutz D2.9L4 Tier 4 Final 49 hp / 36.4 kW	Deutz D2.9L4 Tier 4 Final 49 hp / 36.4 kW	Deutz D2.9L4 Tier 4 Final 49 hp / 36.4 kW	Deutz D2.9L4 Tier 4 Final 49 hp / 36.4 kW
Dual Fuel Engine	Kubota DF WG2503 61 hp / 45.5 kW	Kubota DF WG2503 61 hp / 45.5 kW	Kubota DF WG2503 61 hp / 45.5 kW	Kubota DF WG2503 61 hp / 45.5 kW

*Certain options or country standards increase weight.

**Ground bearing pressure applies to standard tires.

Specifications may change to meet country standards or with addition of optional equipment.

400S

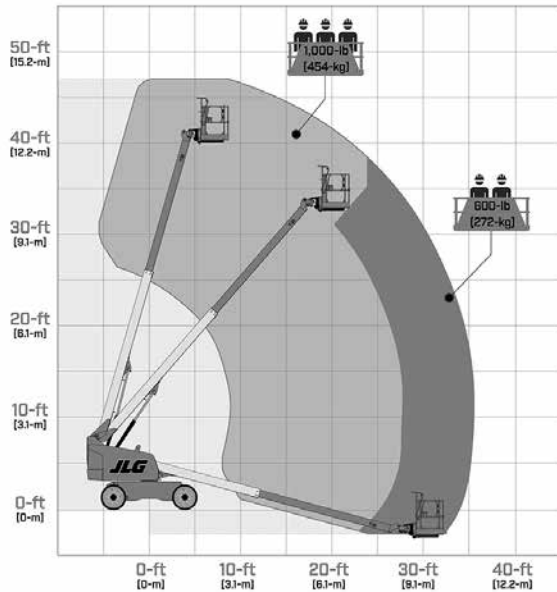

460SJ

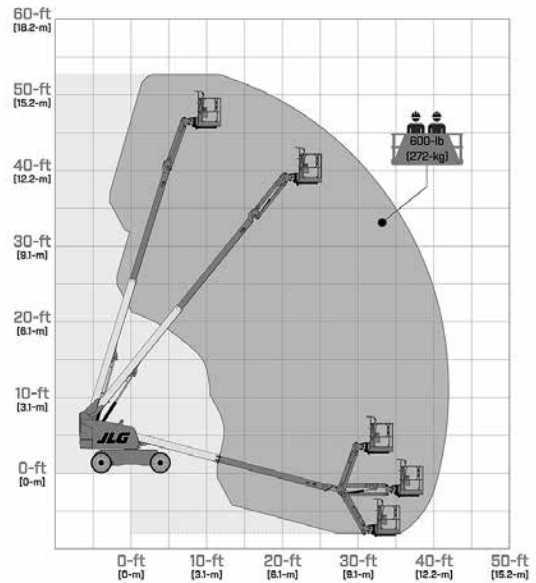

400S HC3

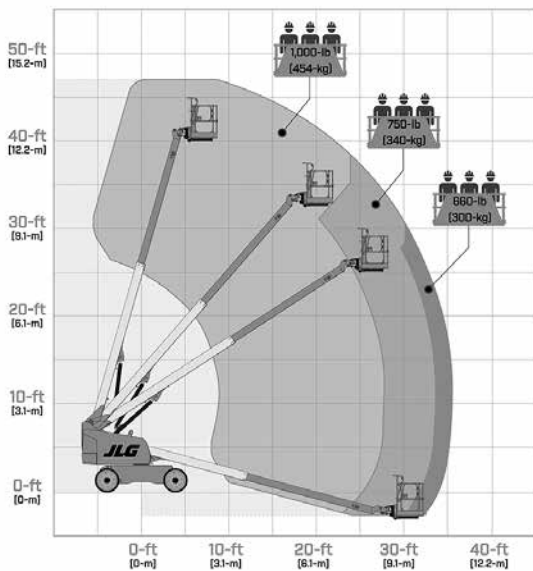

460SJ HC3

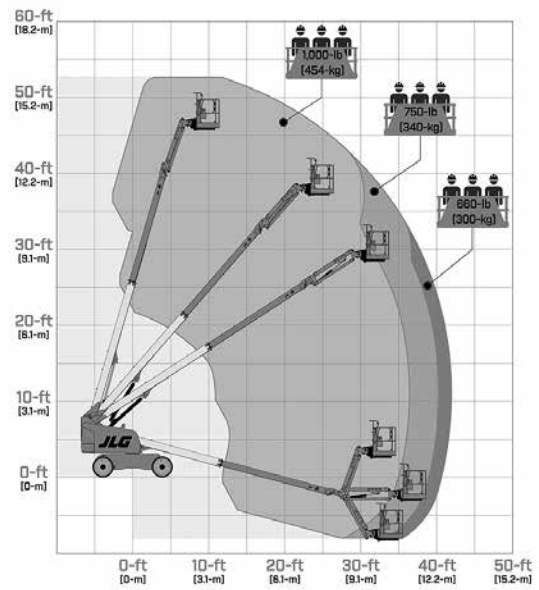

SPECIAL FEATURES INCLUDE:

- 45% gradeability (2WD-30%).
- 100% more platform capacity than most competitors.
- Revolutionary WorkStation in the Sky® options and accessories.
- Up to 39-ft (12-m) horizontal reach.
- SkyGuard SkyLine™
- Load sensing system

HC3

3 Capacity Zones - Each rated for up to 3 occupants + tools/materials

400 CRAWLER SERIES

Telescopic Boom Lifts

	400SC	460SJC
Platform Height	39-ft 6.5-in / 12.05-m	45-ft 5.4-in / 13.88-m
Horizontal Outreach	33-ft / 10-m	39-ft / 12-m
Up and Over Height	N/A	N/A
Swing	360 Degrees Continuous	360 Degrees Continuous
Platform Capacity-Unrestricted	600-lb / 272-kg	600-lb / 272-kg
Platform Capacity-Restricted	1,000-lb / 454-kg	600-lb / 272-kg
Platform Rotator	180 Degrees Hydraulic	180 Degrees Hydraulic
Jib Length (Range of Articulation)	N/A	6-ft / 1.83-m
JibPLUS*	N/A	N/A
Platform Size	36 x 96-in / 0.91 x 2.44-m	36 x 96-in / 0.91 x 2.44-m
Overall Width	7-ft 4-in / 2.23-m	7-ft 4-in / 2.23-m
Overall Width—Axles Extended	N/A	N/A
Tailswing	3.14-ft / 0.96-m	3.14-ft / 0.96-m
Stowed Height	7-ft 7.5-in / 2.32-m	7-ft 7.2-in / 2.32-m
Stowed Length	24-ft 10-in / 7.57-m	29-ft 3-in / 8.9-m
Stowed Length (Drive)	N/A	N/A
Wheelbase	7-ft 5-in / 2.25-m	7-ft 5-in / 2.25-m
Ground Clearance	16-in / 41-cm	16-in / 41-cm
Weight*	14,559-lb / 6,603-kg	17,998-lb / 8,164-kg
Max. Ground Bearing Pressure**	5.21 psi / .366-kg/cm ²	8.35 psi / .587-kg/cm ²
Drive Speed 2WD/4WD	1.6 mph / 2.57 km/h	1.8 mph / 2.9 km/h
Lift/Lower Speed	33/33 seconds	34/34 seconds
Gradeability 2WD/4WD	51%	51%
Tilt Cut-Out	5 Degrees	5 Degrees
Slope Leveling Capacity	N/A	N/A
Slope Leveling Capacity	N/A	N/A
Turning Radius (inside) 2WS/4WS	Zero	Zero
Turning Radius (outside) 2WS/4WS	Zero	Zero
Max Wind Speed Rating	28 mph / 12.5 m/s	28 mph / 12.5 m/s
Axle Oscillation	-	-
Type of Tracks***	Rubber	Rubber
Track Width	15.7-in / 40-cm	15.7-in / 40-cm
Electrical System	12V DC	12V DC
Hydraulic Reservoir	36 gal / 136.27 L	36 gal / 136.27 L
Fuel Tank Capacity	22 gal / 83.3 L	31 gal / 117 L
Diesel Engine	Deutz D2.9L4 Tier 4 Final 49 hp / 36.4 kW	Deutz D2.9L4 Tier 4 Final 49 hp / 36.4 kW
Dual Fuel Engine	-	-

*Certain options or country standards increase weight.

**Ground bearing pressure applies to standard tracks.

***Optional non-marking rubber and steel tracks available.

Specifications may change to meet country standards or with addition of optional equipment.

400SC

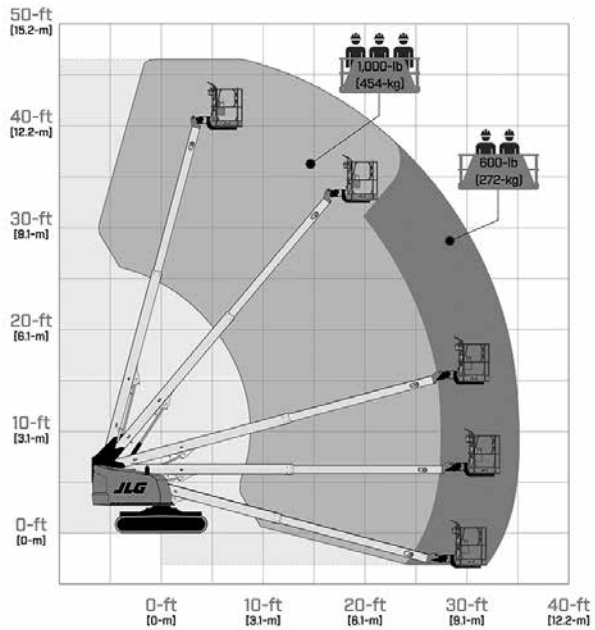

460SJC

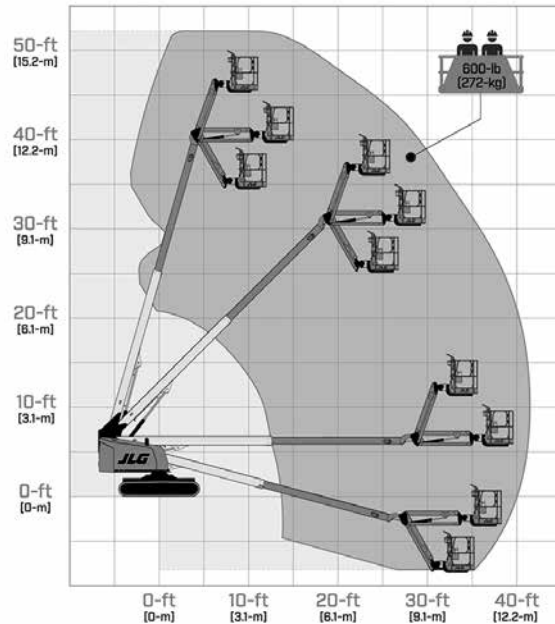

SPECIAL FEATURES INCLUDE:

- Better mobility with a zero turning radius.
- Increased flotation with a choice of tracks.
- Ease of control with a unique single-joystick control.
- 1,000-lb (454-kg) dual capacity (400SC).
- Articulating Jib provides reach versatility.
- SkyGuard SkyLine™
- Load sensing system

600 SERIES

Telescopic Boom Lifts

	600S	600S HC3	660SJ	660SJ HC3
Platform Height	59-ft 8-in / 18.18-m	59-ft 8-in / 18.18-m	65-ft 8-in / 20.02-m	65-ft 8-in / 20.02-m
Horizontal Outreach	50-ft 2-in / 15.29-m	50-ft 2-in / 15.29-m	57-ft 1-in / 17.40-m	57-ft 1-in / 17.40-m
Up and Over Height	N/A	N/A	N/A	N/A
Swing	360 Degrees Continuous	360 Degrees Continuous	360 Degrees Continuous	360 Degrees Continuous
Platform Capacity-Unrestricted	600-lb / 272-kg	660-lb / 300-kg	550-lb / 250-kg	660-lb / 300-kg
Platform Capacity-Restricted	1,000-lb / 454-kg	750/1,000-lb / 340/454-kg	750-lb / 340-kg	750/1,000-lb / 340/454-kg
Platform Rotator	160 Degrees Hydraulic	160 Degrees Hydraulic	180 Degrees Hydraulic	180 Degrees Hydraulic
Jib Length (Range of Articulation)	N/A	N/A	6-ft / 1.83-m / 132 Degrees (+71,-61)	6-ft / 1.83-m / 131 Degrees
JibPLUS*	N/A	N/A	N/A	N/A
Platform Size	36 x 96-in / 0.91 x 2.44-m	36 x 96-in / 0.91 x 2.44-m	36 x 96-in / 0.91 x 2.44-m	36 x 96-in / 0.91 x 2.44-m
Overall Width	8-ft 2-in / 2.48-m	8-ft 2-in / 2.48-m	8-ft 2-in / 2.48-m	8-ft 2-in / 2.48-m
Overall Width—Axles Extended	N/A	N/A	N/A	N/A
Tailswing	4-ft / 1.22-m	4-ft / 1.22-m	4-ft / 1.22-m	4-ft / 1.22-m
Stowed Height	8-ft 2.4-in / 2.50-m	8-ft 2.4-in / 2.50-m	8-ft 2.4-in / 2.50-m	8-ft 5.4-in / 2.58-m
Stowed Length	28-ft 7-in / 8.71-m	28-ft 7-in / 8.71-m	35-ft 4.7-in / 10.79-m	33-ft 0.4-in / 10.01-m
Stowed Length (Drive)	N/A	N/A	N/A	N/A
Wheelbase	8-ft 2.7-in / 2.51-m	8-ft 2.7-in / 2.51-m	8-ft 2.7-in / 2.51-m	8-ft 2.7-in / 2.51-m
Ground Clearance	11.3-in / 29-cm	11.3-in / 29-cm	11.3-in / 29-cm	11.3-in / 29-cm
Weight*	21,647-lb / 9,819-kg	22,900-lb / 10,387-kg	25,341-lb / 11,494-kg	29,281-lb / 13,281-kg
Max. Ground Bearing Pressure**	83 psi / 5.84-kg/cm ²	84 psi / 5.9-kg/cm ²	86 psi / 6-kg/cm ²	112 psi / 7.9-kg/cm ²
Drive Speed 2WD/4WD	3.8 mph / 6.3 km/h	3.8 mph / 6.3 km/h	3.8 mph / 6.3 km/h	3.8 mph / 6.3 km/h
Lift/Lower Speed	55/55 seconds	55/55 seconds	55/55 seconds	55/55 seconds
Gradeability 2WD/4WD	45%	45%	45%	45%
Tilt Cut-Out	5 Degrees	5 Degrees	5 Degrees	5 Degrees
Slope Leveling Capacity	N/A	N/A	N/A	N/A
Slope Leveling Capacity	N/A	N/A	N/A	N/A
Turning Radius (Inside) 2WS/4WS	9-ft 7-in / 2.92-m / 5-ft 3-in / 1.61-m	9-ft 6.5-in / 2.91-m	9-ft 7-in / 2.92-m / 5-ft 3-in / 1.61-m	9-ft 6.3-in / 2.90-m / 5-ft 3.9-in / 1.62-m
Turning Radius (Outside) 2WS/4WS	19-ft 7-in / 5.96-m / 12-ft 8-in / 3.87-m	18-ft 3.9-in / 5.59-m	19-ft 7-in / 5.96-m / 12-ft 8-in / 3.87-m	18-ft 3.9-in / 5.59-m / 9-ft 11-in / 3.02-m
Max Wind Speed Rating	28 mph / 12.5 m/s	28 mph / 12.5 m/s	28 mph / 12.5 m/s	28 mph / 12.5 m/s
Axle Oscillation	8-in / 20-cm	7.4-in / 19-cm	8-in / 20-cm	7.4-in / 19-cm
Tire Size/Type	355/55D625 Foam-Filled Lug Tread	355/55D625 Foam-Filled Lug Tread	355/55D625 Foam-Filled Lug Tread	355/55D625 Foam-Filled Lug Tread
Electrical System	12V DC	12V DC	12V DC	12V DC
Hydraulic Reservoir	34 gal / 129 L	34 gal / 129 L	34 gal / 129 L	34 gal / 129 L
Fuel Tank Capacity	31 gal / 117 L	31 gal / 117 L	31 gal / 117 L	31 gal / 117 L
Diesel Engine	Deutz D2.9L4 48.8 hp / 36.4 kW Tier 4 Final	Deutz D2.9L4 48.8 hp / 36.4 kW Tier 4 Final	Deutz D2.9L4 48.8 hp / 36.4 kW Tier 4 Final	Deutz D2.9L4 48.8 hp / 36.4 kW Tier 4 Final
Dual Fuel Engine	Ford MSG425-DF 84 hp / 62.6 kW	Ford MSG425-DF 84 hp / 62.6 kW	Ford MSG425-DF 84 hp / 62.6 kW	Ford MSG425-DF 84 hp / 62.6 kW

*Certain options or country standards increase weight.

**Ground bearing pressure applies to standard tires.

Specifications may change to meet country standards or with addition of optional equipment.

600S

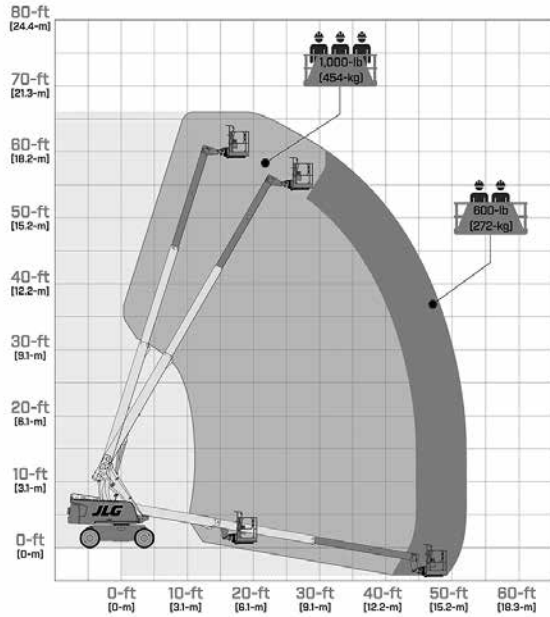

660SJ

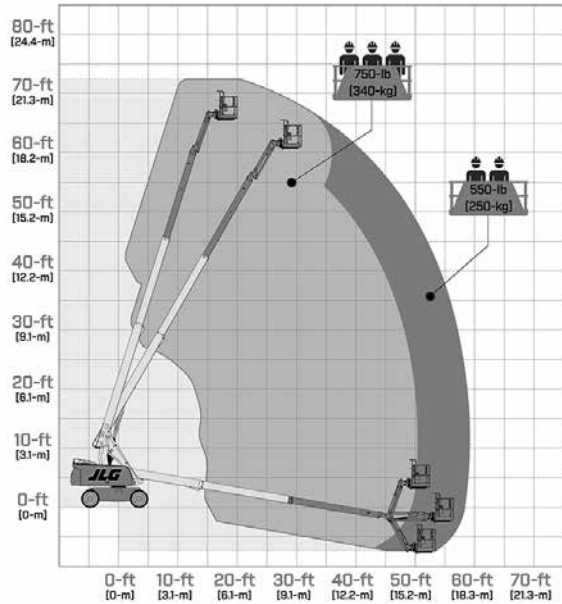

600S HC3

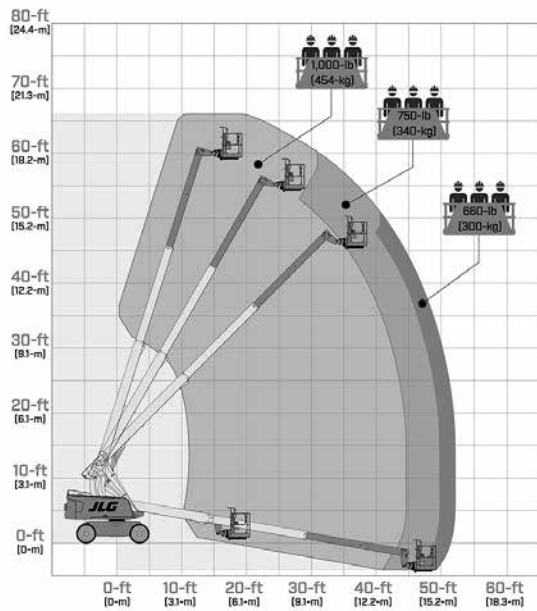

660SJ HC3

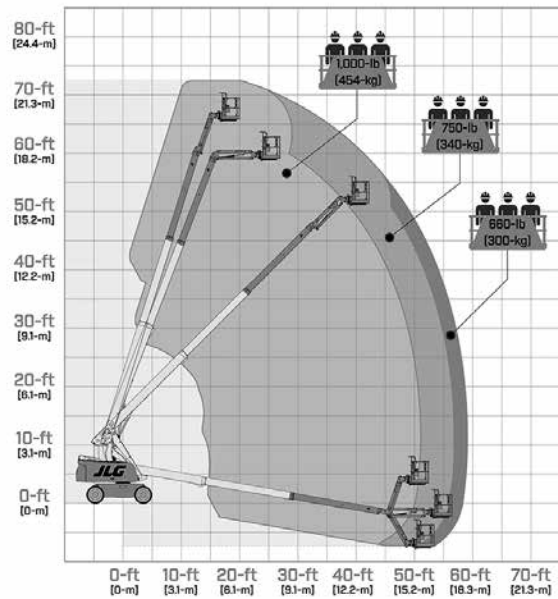

SPECIAL FEATURES INCLUDE:

- The best selling series of boom lifts in the world.
- Easy-to-identify platform controls for reduced operator training time.
- New and improved articulating jibs permit greater reach versatility.
- SkyGuard SkyLine™
- Load sensing system

HC3

3 Capacity Zones - Each rated for up to 3 occupants + tools/materials

600 CRAWLER SERIES

Telescopic Boom Lifts

660SJ

Platform Height	65-ft 7-in / 19.99-m
Horizontal Outreach	57-ft 0.6-in / 17.39-m
Up and Over Height	N/A
Swing	360 Degrees Continuous
Platform Capacity-Unrestricted	550-lb / 249-kg
Platform Capacity-Restricted	750-lb / 340-kg
Platform Rotator	180 Degrees Hydraulic
Jib Length (Range of Articulation)	132 Degrees (+71,-61)
JibPLUS*	N/A
Platform Size	36 x 96-in / 0.91 x 2.44-m
Overall Width	8-ft 2-in / 2.49-m
Overall Width—Axles Extended	N/A
Tailswing	4-ft / 1.22-m
Stowed Height	8-ft 1.2-in / 2.47-m
Stowed Length	35-ft 4.7-in / 10.79-m
Stowed Length (Drive)	N/A
Wheelbase	8-ft 9.9-in / 2.69-m
Ground Clearance	16.7-in / 40-cm
Weight*	27,620-lb / 12,528-kg
Max. Ground Bearing Pressure**	11.3 psi / 0.8-kg/cm ²
Drive Speed 2WD/4WD	1.6 mph / 2.6 km/h
Lift/Lower Speed	55/55 seconds
Gradeability 2WD/4WD	55%
Tilt Cut-Out	5 Degrees
Slope Leveling Capacity	N/A
Slope Leveling Capacity	N/A
Turning Radius (Inside) 2WS/4WS	Zero
Turning Radius (Outside) 2WS/4WS	Zero
Max Wind Speed Rating	28 mph / 12.5 m/s
Axle Oscillation	-
Type of Tracks***	Steel
Track Width	20-in / 51-cm
Electrical System	12V DC
Hydraulic Reservoir	34 gal / 129 L
Fuel Tank Capacity	31 gal / 117 L
Diesel Engine	Deutz TD2.9L4 Tier 4 Final 67 hp / 50 kW
Dual Fuel Engine	-

*Certain options or country standards increase weight.

**Ground bearing pressure applies to standard tracks.

***Available with detachable rubber pads.

Specifications may change to meet country standards or with addition of optional equipment.

660SJC

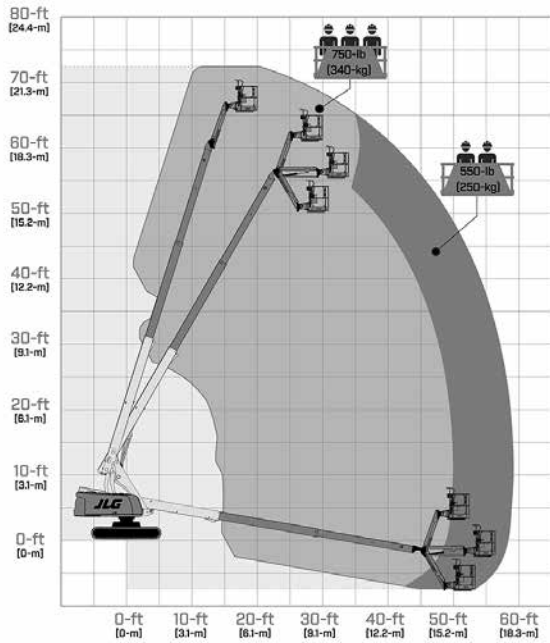

SPECIAL FEATURES INCLUDE:

- Better mobility with a zero turning radius.
- Increased flotation with a choice of tracks.
- Ease of control with a unique single-joystick control.
- SkyGuard SkyLine™
- Load sensing system

670SJ SELF-LEVELING Telescopic Boom Lift

670SJ

Platform Height	66-ft 10-in / 20.36-m
Horizontal Outreach	57-ft 1-in / 17.40-m
Up and Over Height	N/A
Swing	360 Degrees Continuous
Platform Capacity-Unrestricted	550-lb / 250-kg
Platform Capacity-Restricted	750-lb / 340-kg
Platform Rotator	180 Degrees Hydraulic
Jib Length (Range of Articulation)	6-ft / 1.83-m / 132 Degrees (+71,-61)
JibPLUS*	N/A
Platform Size	36 x 96-in / 0.91 x 2.44-m
Overall Width	8-ft 2.4-in / 2.50-m
Overall Width—Axles Extended	N/A
Tailswing	4-ft / 1.22-m
Stowed Height	9-ft 1.2-in / 2.74-m
Stowed Length	35-ft 5-in / 10.68-m
Stowed Length (Drive)	N/A
Wheelbase	-
Ground Clearance	1-ft 1-in / 33-cm
Weight*	25,341-lb / 11,494-kg
Max. Ground Bearing Pressure**	85 psi / 5.98-kg/cm ²
Drive Speed 2WD/4WD	3.8 mph / 6.1 km/hr
Lift/Lower Speed	55/55 seconds
Gradeability 2WD/4WD	45%
Tilt Cut-Out	10 Degrees
Slope Leveling Capacity	10 Degrees Fore/Aft
Slope Leveling Capacity	10 Degrees Side to Side
Turning Radius (Inside) 2WS/4WS	8-ft 4.4-in / 2.55-m
Turning Radius (Outside) 2WS/4WS	18-ft 7.6-in / 5.68-m
Max Wind Speed Rating	28 mph / 12.5 m/s
Axle Oscillation	-
Tire Size/Type	Foam Filled
Electrical System	12V DC
Hydraulic Reservoir	34 gal / 129 L
Fuel Tank Capacity	31 gal / 117 L
Diesel Engine	Deutz T4F 67 hp 50kW
Dual Fuel Engine	-

* Certain options or country standards increase weight

**Ground bearing pressure applies to standard tires.

670SJ

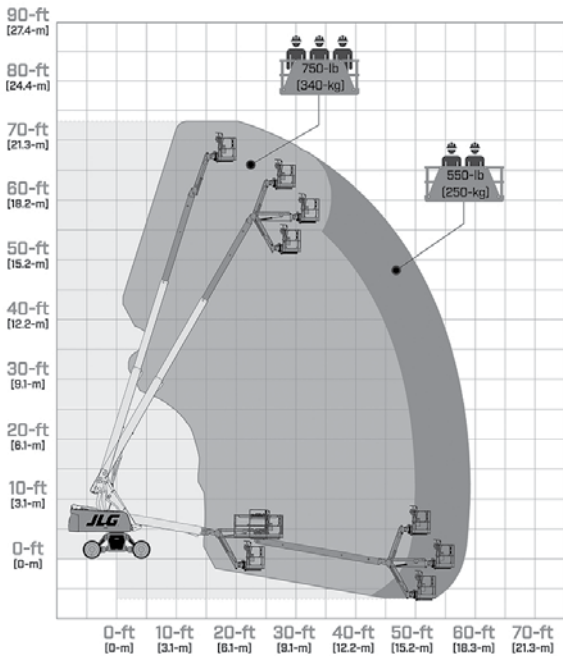

THE SELF-LEVELING BOOM TRAVERSES SUBSTANTIALLY UNEVEN GROUND AT FULL HEIGHT TO PROVIDE:

- Automatic Self Leveling, to enable safe "drive while at height" productivity with the ability to get closer to the job quicker.
- Maximized machine utilization with unparalleled 10 degree slope capability to avoid repositioning trial and error.
- Unprecedented platform stability that may reduce worker fatigue and increase operator environmental awareness.
- Reduction of costs, risks, and time wasted in cribbing, grading, or renting larger equipment.
- Minimization of objects bouncing around and out of platform for a more efficient, safer jobsite.
- Fully ANSI 92.20 compliant with an industry leading allowable operating slope.



800 SERIES

Telescopic Boom Lifts

	800S	800S HC3	860SJ	860SJ HC3
Platform Height	80-ft / 24.38-m	80-ft / 24.38-m	86-ft / 26.21-m	86-ft / 26.21-m
Horizontal Outreach	71-ft / 21.64-m	71-ft 3-in / 21.78	75-ft / 22.86-m	74-ft 8.9-in / 22.78-m
Up and Over Height	N/A	N/A	N/A	N/A
Swing	360 Degrees Continuous	360 Degrees Continuous	360 Degrees Continuous	360 Degrees Continuous
Platform Capacity-Unrestricted	500-lb / 227-kg	500-lb / 227-kg	500-lb / 227-kg	500-lb / 227-kg
Platform Capacity-Restricted ¹	1,000-lb / 454-kg	750/1000-lb / 340/454-kg	750-lb / 340-kg	750/1000-lb / 340/454-kg
Platform Rotator	180 Degrees Hydraulic	180 Degrees Hydraulic	180 Degrees Hydraulic	180 Degrees Hydraulic
Jib Length (Range of Articulation)	N/A	N/A	6-ft / 1.83-m / 131 Degrees (+70.5, -60.5)	6-ft / 1.83-m / 131 Degrees (+70.5, -60.5)
JibPLUS [*]	N/A	N/A	N/A	N/A
Platform Size	36 x 96-in / 0.91 x 2.44-m	36 x 96-in / 0.91 x 2.44-m	36 x 96-in / 0.91 x 2.44-m	36 x 96-in / 0.91 x 2.44-m
Overall Width	8-ft 2-in / 2.49-m	8-ft 2-in / 2.49-m	8-ft 2-in / 2.49-m	8-ft 2-in / 2.49-m
Overall Width—Axles Extended	N/A	N/A	N/A	N/A
Tailswing	4-ft 8-in / 1.42-m	4-ft 8-in / 1.42-m	4-ft 8-in / 1.42-m	4-ft 8-in / 1.42-m
Stowed Height	9-ft 11-in / 3.02-m	9-ft 8.1-in / 2.95-m	9-ft 8.1-in / 2.95-m	9-ft 8.1-in / 2.95-m
Stowed Length	37-ft 5.9-in / 11.43-m	37-ft 6-in / 11.43-m	40-ft / 12.19-m	40-ft / 12.19-m
Stowed Length (Drive)	N/A	N/A	N/A	N/A
Wheelbase	10-ft / 3.05-m	10-ft / 3.05-m	10-ft / 3.05-m	10-ft / 3.05-m
Ground Clearance	11-in / 28-cm	11-in / 28-cm	11-in / 28-cm	11-in / 28-cm
Weight*	34,150-lb / 15,490-kg	33,030-lb / 14,982-kg	36,840-lb / 16,710-kg	38,040-lb / 17,255-kg
Max. Ground Bearing Pressure**	72 psi / 5.06-kg/cm2	72 psi / 5.06-kg/cm2	81 psi / 5.69-kg/cm2	104.6 psi / 7.4-kg/cm2
Drive Speed 2WD/4WD	3.5 mph / 5.6 km/h	4.13 mph / 6.65 km/h	3.5 mph / 5.6 km/h	4.13 mph / 6.65 km/h
Lift/Lower Speed	110/110 seconds	110/110 seconds	110/110 seconds	110/110 seconds
Gradeability 2WD/4WD	25%--45%	25%--45%	25%--45%	25%--45%
Tilt Cut-Out	4 Degrees	4 Degrees	4 Degrees	4 Degrees
Slope Leveling Capacity	N/A	N/A	N/A	N/A
Slope Leveling Capacity	N/A	N/A	N/A	N/A
Turning Radius (Inside) 2WS/AWS	12-ft 6-in / 3.8-m	14-ft 7.7-in / 4.5-m	12-ft 6-in / 3.8-m	14-ft 7.7-in / 4.5-m
Turning Radius (Outside) 2WS/AWS	19-ft 8-in / 6.02-m	21-ft 7-in / 6.6-m	19-ft 8-in / 6.02-m	21-ft 7-in / 6.6-m
Max Wind Speed Rating	28 mph / 12.5 m/s	28 mph / 12.5 m/s	28 mph / 12.5 m/s	28 mph / 12.5 m/s
Axle Oscillation	6.8-in / 17-cm	6.8-in / 17-cm	6.8-in / 17-cm	6.8-in / 17-cm
Tire Size/Type	18-625 Foam-Filled Lug Tread	15-625 Foam-Filled Lug Tread	15-625 Foam-Filled Lug Tread	15-625 Foam-Filled Lug Tread
Electrical System	12V DC	12V DC	12V DC	12V DC
Hydraulic Reservoir	48 gal / 181.7 L	48 gal / 181.7 L	48 gal / 181.7 L	34 gal / 129 L
Fuel Tank Capacity	31 gal / 117.35 L	31 gal / 117.35 L	31 gal / 117.35 L	31 gal / 117.35 L
Diesel Engine	Deutz TD2.9L4 Tier 4 Final 67 hp / 50 kW	Deutz TD2.9L4 Tier 4 Final 67 hp / 50 kW	Deutz TD2.9L4 Tier 4 Final 67 hp / 50 kW	Deutz TD2.9L4 Tier 4 Final 67 hp / 50 kW
Dual Fuel Engine	Ford MSG425-DF 84 hp / 62.6 kW	Ford MSG425-DF 84 hp / 62.6 kW	Ford MSG425-DF 84 hp / 62.6 kW	Ford MSG425-DF 84 hp / 62.6 kW

*Certain options or country standards increase weight.

**Ground bearing pressure applies to standard tires.

Specifications may change to meet country standards or with addition of optional equipment.

1. 500-lb capacity rated for 2 occupants plus tools/materials

800S

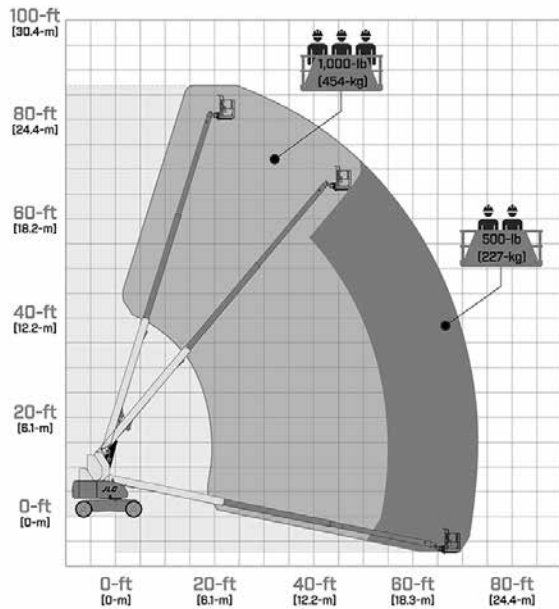

860SJ

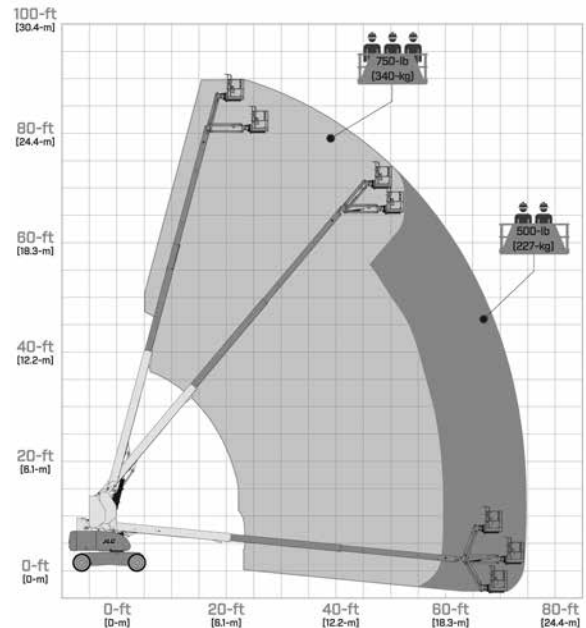

800S HC3

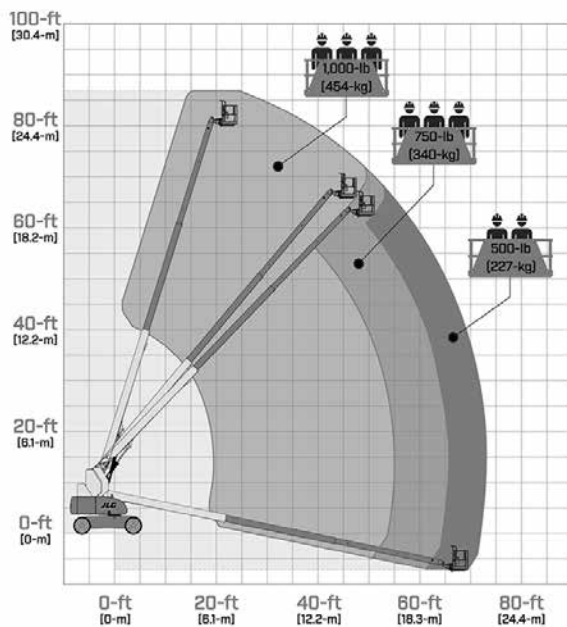

860SJ HC3

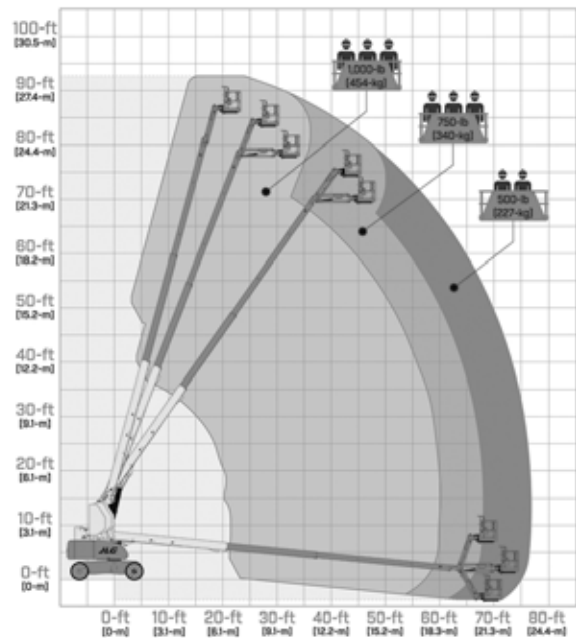

SPECIAL FEATURES INCLUDE:

- Improved access—A narrow fixed-width frame eliminates the need for extendable axles and allows for faster set-up.
- Optimum performance—Go from the ground to 80-ft (24.38-m) in less than 67 seconds, up to 40% faster than the competition.
- Lower operating costs—Better fuel efficiency, Control ADE (Advanced Design Electronics) system, and a swing out engine tray.
- Greater mobility—Powers through mud with 4WD, oscillating axles and a low weight.
- SkyGuard SkyLine™
- Load sensing system

HC3

3 Capacity Zones - Each rated for up to 3 occupants + tools/materials

ULTRA SERIES

Telescopic Boom Lifts

	1200SJP	1350SJP	1500SJ	1850SJ
Platform Height	120-ft / 36.58-m	135-ft 41.15-m	150-ft / 45.7-m	185-ft 7-in / 56.56-m
Horizontal Outreach	75-ft / 22.86-m	80-ft / 24.38-m	80-ft / 24.38-m	80-ft / 24.38-m
Up and Over Height	-	-	-	-
Swing	360 Degrees Continuous	360 Degrees Continuous	360 Degrees Continuous	360 Degrees Continuous
Platform Capacity-Unrestricted	500-lb / 227-kg	500-lb / 227-kg	500-lb / 227-kg	500-lb / 227-kg
Platform Capacity-Restricted	1,000-lb / 454-kg	1,000-lb / 454-kg	1,000-lb / 454-kg	1,000-lb / 454-kg
Platform Rotator	180 Degrees	180 Degrees	180 Degrees	173 Degrees
Jib Length (Range of Articulation)	8-ft / 2.44-m / 130 Degrees (+75,-55)	8-ft / 2.44-m / 130 Degrees (+75,-55)	Retracted 15-ft 2-in / 4.62-m Extended 25-ft / 7.62-m / 120 Degrees (+75,-45)	Retracted 13-ft / 3.96-m Extended 20-ft / 6.1-m / 120 Degrees (+75,-45)
JibPLUS [†]	180 Degrees Horizontal	181 Degrees Horizontal	N/A	N/A
Platform Size	36 x 96-in / 0.91 x 2.44-m	36 x 96-in / 0.91 x 2.44-m	36 x 96-in / 0.91 x 2.44-m	36 x 96-in / 0.91 x 2.44-m
Overall Width	8-ft 2-in / 2.49-m	8-ft 2-in / 2.49-m	8-ft 2-in / 2.49-m	8-ft 2-in / 2.49-m
Overall Width—Axles Extended	12-ft 6-in / 3.81-m	12-ft 6-in / 3.81-m	12-ft 6-in / 3.81-m	16-ft 6-in / 5.03-m
Tailswing	5-ft 6-in / 1.67-m	5-ft 6-in / 1.67-m	5-ft 6-in / 1.67-m	7-ft 7-in / 2.32-m
Stowed Height	10-ft / 3.05-m	10-ft / 3.05-m	10-ft / 3.05-m	10-ft / 3.05-m
Stowed Length	34-ft 11-in / 10.64-m	38-ft 11-in / 11.86-m	43-ft / 13.11-m	47-ft 9.5-in / 14.57-m
Stowed Length (Drive)	N/A	N/A	N/A	N/A
Wheelbase	12-ft 6-in / 3.81-m	12-ft 6-in / 3.81-m	12-ft 6-in / 3.81-m	17-ft 1.5-in / 5.22-m
Ground Clearance				
— Axle	12-in / 30-cm	12-in / 30-cm	12-in / 30-cm	13.5-in / 34-cm
— Chassis	25.5-in / 65-cm	25.5-in / 65-cm	25.5-in / 65-cm	16.25-in / 41-cm
Weight*	41,100-lb / 18,650-kg	44,750-lb / 20,300-kg	48,000-lb / 21,772-kg	59,900-lb / 27,170-kg
Max. Ground Bearing Pressure**	99 psi / 7.0-kg/cm ²	107 psi / 7.52-kg/cm ²	113 psi / 7.94-kg/cm ²	119.6 psi / 8.41-kg/cm ²
Drive Speed 2WD/4WD	3.25 mph / 5.2 km/h	3.25 mph / 5.2 km/h	3.0 mph / 4.8 km/h	2.8 mph / 4.5 km/h
Lift/Lower Speed	75/85 seconds	75/85 seconds	80/85 seconds	130/145 seconds
Gradeability 2WD/4WD	45%	45%	40%	40%
Tilt Cut-Out	5 Degrees	5 Degrees	4 Degrees	5 Degrees
Slope Leveling Capacity	N/A	N/A	N/A	N/A
Slope Leveling Capacity	N/A	N/A	N/A	N/A
Turning Radius (Inside) 2WS/4WS	8-ft / 2.44-m	8-ft / 2.44-m	8-ft / 2.44-m	7-ft 6.75-in / 2.30-m
Turning Radius (Outside) 2WS/4WS	19-ft 4-in / 5.89-m	19-ft 4-in / 5.89-m	19-ft 4-in / 5.89-m	21-ft 7.75-in / 6.60-m
Max Wind Speed Rating	28 mph / 12.5 m/s	28 mph / 12.5 m/s	28 mph / 12.5 m/s	28 mph / 12.5 m/s
Axle Oscillation	12-in / 30-cm	12-in / 30-cm	12-in / 30-cm	0-in / 0-cm
Crab Steer Ratio ²	1:1	1:1	1:1	1:1
Tire Size/Type	445/50D710 Foam-Filled	445/50D710 Foam-Filled	445/50D710 Foam-Filled	445/50D710 Foam-Filled
Electrical System	12V DC	12V DC	12V DC	12V DC
Hydraulic Reservoir	55 gal / 208.2 L	55 gal / 208.2 L	55 gal / 208.2 L	75.1 gal / 284.2 L
Fuel Tank Capacity	31 gal / 117.35 L	31 gal / 117.35 L	31 gal / 117.35 L	45 gal / 170 L
Diesel Engine	Deutz TD2.9L4 Tier 4 Final 74.2 hp / 55.4 kW	Deutz TD2.9L4 Tier 4 Final 74.2 hp / 55.4 kW	Deutz TD2.9L4 Tier 4 Final 74.2 hp / 55.4 kW	Deutz TCD3.6L Tier IVF 99.8 hp / 74.4 kW
Dual Fuel Engine	-	-	-	-

*Certain options or country standards increase weight.

**Ground bearing pressure applies to standard tires.

1. Capacity is limited to 500-lb when JibPLUS[†] is extended horizontally.

2. Ratio of forward travel to lateral travel.

Specifications may change to meet country standards or with addition of optional equipment.

1200SJP

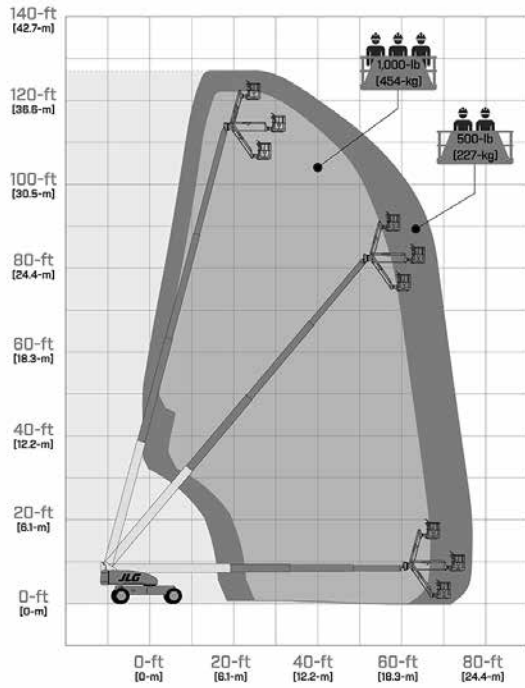

1350SJP

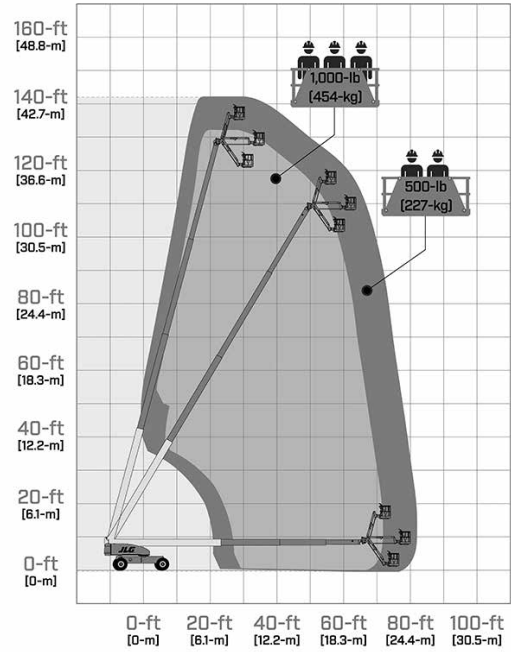

1500SJ

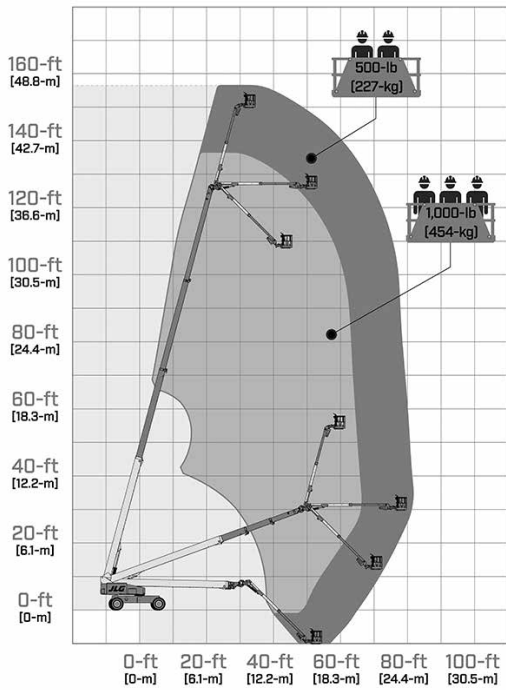

1850SJ

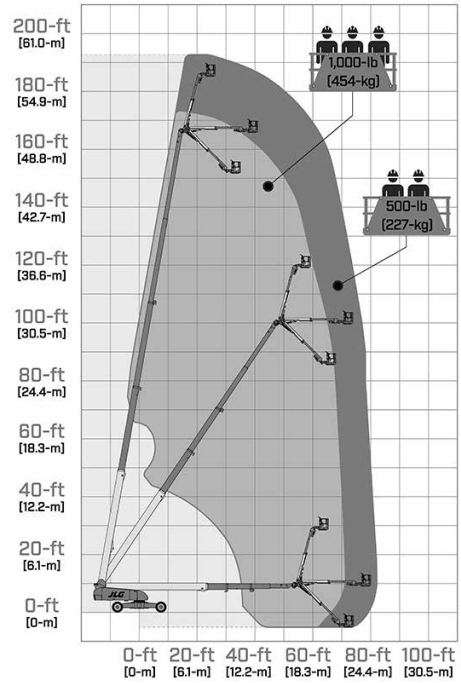

TOW-PRO® SERIES

Towable Boom Lifts

	ET350	T350	ET500J	T500J
Platform Height	34-ft 5-in / 10.5-m	34-ft 5-in / 10.5-m	50-ft 5-in / 15.2-m	50-ft 5-in / 15.2-m
Horizontal Outreach				
— Working Outreach	18-ft 9-in / 5.7-m	18-ft 9-in / 5.7-m	31-ft 6-in / 9.6-m	31-ft 6-in / 9.6-m
— Centerline to Platform Edge	20-ft / 6.1-m	20-ft / 6.1-m	31-ft / 9.45-m	31-ft / 9.45-m
Swing	410 Degrees Non-Continuous	410 Degrees Non-Continuous	410 Degrees Non-Continuous	410 Degrees Non-Continuous
Platform Capacity				
— Standard Platform	500-lb / 227-kg	500-lb / 227-kg	500-lb / 227-kg	500-lb / 227-kg
— Optional Platform Rotator	440-lb / 200-kg	440-lb / 200-kg	440-lb / 200-kg	440-lb / 200-kg
Material Hook Capacity	500-lb / 227-kg	500-lb / 227-kg	500-lb / 227-kg	500-lb / 227-kg
Platform Rotator (Optional)	90 Degrees Manual	90 Degrees Manual	90 Degrees Manual	90 Degrees Manual
Jib				
— Length	N/A	N/A	4-ft / 1.22-m	4-ft / 1.22-m
— Vertical Motion	N/A	N/A	130 Degrees (+75, -55)	130 Degrees (+75, -55)
Platform Size	30 x 48-in / 0.76 x 1.22-m	30 x 48-in / 0.76 x 1.22-m	30 x 48-in / 0.76 x 1.22-m	30 x 48-in / 0.76 x 1.22-m
Overall Width	5-ft 2.75-in / 1.6-m	5-ft 2.75-in / 1.6-m	5-ft 7.5-in / 1.7-m	5-ft 7.5-in / 1.7-m
Outrigger Footprint—Length	11-ft 7-in / 3.5-m	11-ft 7-in / 3.5-m	12-ft 4-in / 3.8-m	12-ft 4-in / 3.8-m
Outrigger Footprint—Width	10-ft 5-in / 3.2-m	10-ft 5-in / 3.2-m	12-ft 8-in / 3.9-m	12-ft 8-in / 3.9-m
Stowed Height	6-ft 7-in / 2.0-m	6-ft 7-in / 2.0-m	6-ft 6.75-in / 2-m	6-ft 6.75-in / 2-m
Stowed Length	21-ft 9.5-in / 6.6-m	21-ft 9.5-in / 6.6-m	27-ft 3.75-in / 8.32-m	27-ft 3.75-in / 8.32-m
Leveling Capability	11 Degrees	11 Degrees	11 Degrees	11 Degrees
Weight	3,600-lb / 1,633-kg	3,600-lb / 1,633-kg	5,200-lb / 2,359-kg	5,200-lb / 2,359-kg
Max. Ground Bearing Pressure	23 psi / 1.62-kg/cm2	23 psi / 1.62-kg/cm2	31 psi / 2.18-kg/cm2	31 psi / 2.18-kg/cm2
Max Wind Speed Rating	28 mph / 12.5 m/s	28 mph / 12.5 m/s	28 mph / 12.5 m/s	28 mph / 12.5 m/s
Towing Speed Rating	65 mph / 105 Km/h	65 mph / 105 Km/h	65 mph / 105 Km/h	65 mph / 105 Km/h
Max Gradability	20%	20%	20%	20%
Tongue Weight	250-lb / 114-kg	250-lb / 114-kg	450-lb / 204-kg	450-lb / 204-kg
Brakes	Hydraulic Surge	Hydraulic Surge	Hydraulic Surge	Hydraulic Surge
Parking Brakes	Standard	Standard	Standard	Standard
Tire Size/Type	ST215/75 R14 Pneumatic	ST215/75 R14 Pneumatic	ST225/75 R15 Pneumatic	ST225/75 R15 Pneumatic
DC Power	24V DC	24V DC	24V DC	24V DC
Batteries	4 x 6V, 220 amp-hr	N/A	4 x 6V, 220 amp-hr	N/A
Gasoline Engine	N/A	Honda GX 270—8.4 hp	N/A	Honda GX 270—8.4 hp
Fuel Tank Capacity	N/A	1.6 gal / 6.1 L	N/A	1.6 gal / 6.1 L
Hydraulic Reservoir	4.0 gal / 15.14 L	4.0 gal / 15.14 L	6.0 gal / 22.71 L	6.0 gal / 22.71 L

ET350

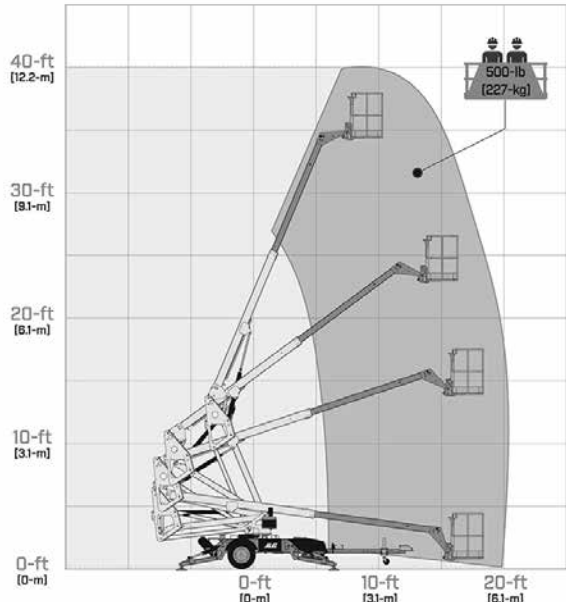

ET500J



T350

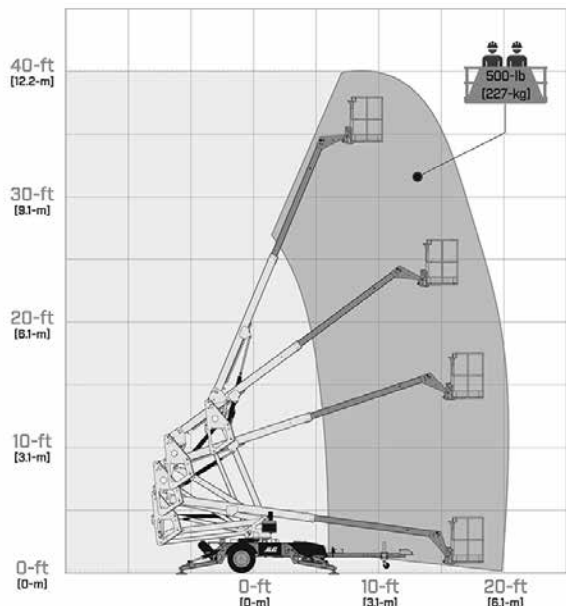

T500J

