

METRO-LED SERIES II

LIGHTING TOWER



Performance

Height Stowed	2.40 m
Length Stowed	
Towbar in Transport Position	2.25 m
Towbar in Towing Position	2.90 m
Stowed Width	1.75 m
Weight GVM	1100 kg
Length with Outriggers Extended	2.34 m
Width with Outriggers Extended	2.15 m
Mast Max. Elevation	9.00 m
Wind Speed Rating	100 km/hr

Standard Specifications

Power

Engine	Kubota Z482
Fuel Type	Diesel
Fuel Consumption (litre per hour)	0.63 L/hr
Running Time (hours)	190+ hours
Generator	48 V DC
Lights	LED
Light Power	4 x 300W
Control System	Electronic Control
Noise Level @ 7m radius	< 60 dB(A)
Fuel Tank Capacity	125 L

Travel

Wheels	Sunraysia Style 14"x6J
Tyres	185R14C
Towing Speed (maximum)	80 km/ hr

Mast System

Lift	Hydraulic
Mast Lift Time	25 seconds
Mast Lower Time	13 seconds
Lighthouse Tilt	50° Electro Mechanical
Lighthouse Rotate	116° (+58°/-58°)
Hydraulic System Pump	
Voltage	12V DC
Pressure	240 bar (3500psi)
Flow Rate	0.78 cm ³ /rev
Function Control	Electric over Hydraulic

Standard Features

- External Emergency Stop
- Moulded Hoods
- Bunding for all Fluids (110%)
- Forklift Tyne Pockets
- Crane Lifting Point
- Folding Drawbar
- Long Extension Wind Down Outriggers
- 50° Light Head Tilt
- 116° Rotation of Light Head
- Torsion Independent Axle
- Cable Mechanical Disc brakes
- Sunraysia Style Rims
- LED Trailer Traffic Lights
- 7 Pin Flat Trailer Plug.



This 9 m tower features 4 x LED lights on a 48 V 'extra low voltage' system and weighs just 1100 kg, enabling easy one person set-up. Designed and manufactured in Australia the Metro-LED tower SLL provides the value you need without sacrificing performance and quality you require.

Accessories & Options

- Upgrade Electronic Module including
- Auto-Start and Advanced Engine Management
- Battery Isolator Lockable
- Battery Isolator LockSafe
- Handbrake Mast Release
- Starter Isolator Lockable
- Starter Isolator LockSafe
- Spark Arrestor Muffler
- Burst Protection On Hydraulic Hosing
- Jump Start Receptacle
- Wheel Chocks
- Steel Hoods
- 4.5 kg Fire Extinguisher
- Rotating Amber Beacon or Strobe Light



METRO-LED SERIES II

LIGHTING TOWER

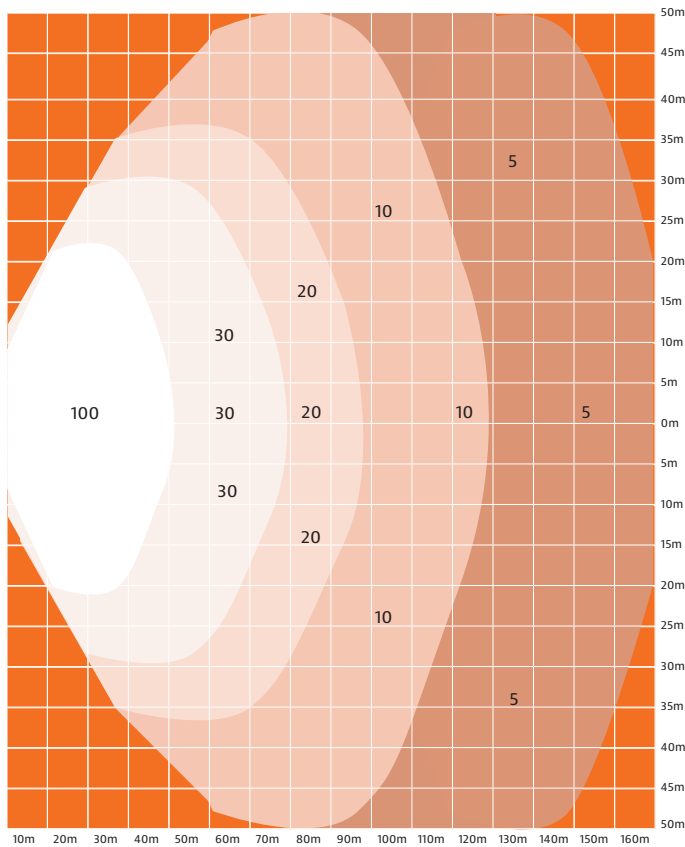
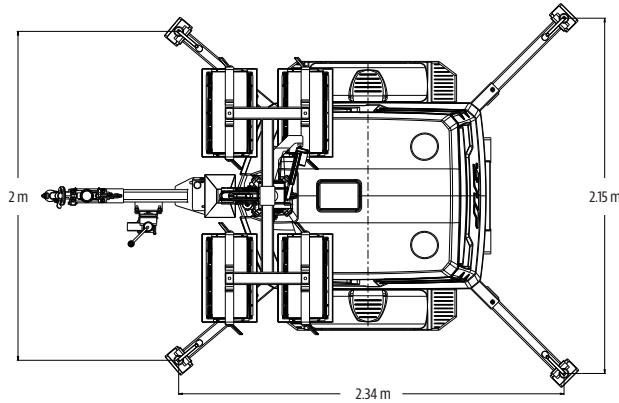

The JLG "1 & 5" Warranty

JLG Industries, Inc. backs its products with its exclusive "1 & 5" Warranty. We provide coverage on all products for one (1) full year and cover all specified major structural components for five (5) years. Due to continuous product improvements, we reserve the right to make specification and/ or equipment changes without prior notification.

R072222



JLG Industries (Australia)

358 Park Road
Regents Park, NSW 2143
Telephone 02 8718 6300
Fax 02 8718 6377
www.jlg.com.au

An Oshkosh Corporation Company